



Department  
of Health

# Health Technical Memorandum 05-02: Firecode Guidance in support of functional provisions (Fire safety in the design of healthcare premises) 2015 edition



September 2015

Health Technical Memorandum  
05-02: Firecode  
Guidance in support of  
functional provisions  
(Fire safety in the design of  
healthcare premises)

2015 edition



© Crown copyright 2015

You may re-use this information (not including logos) free of charge in any format or medium, under the terms of the Open Government Licence. To view this licence, visit [www.nationalarchives.gov.uk/doc/open-government-licence/](http://www.nationalarchives.gov.uk/doc/open-government-licence/) or write to the Information Policy Team, The National Archives, Kew, London TW9 4DU, or email: [psi@nationalarchives.gsi.gov.uk](mailto:psi@nationalarchives.gsi.gov.uk).

This document is available from our website at <https://www.gov.uk/government/collections/health-technical-memorandum-disinfection-and-sterilization>

# Preface

## About Health Technical Memoranda

Health Technical Memoranda (HTMs) give comprehensive advice and guidance on the design, installation and operation of specialised building and engineering technology used in the delivery of healthcare.

The focus of Health Technical Memorandum guidance remains on healthcare-specific elements of standards, policies and up-to-date established best practice. They are applicable to new and existing sites, and are for use at various stages during the whole building lifecycle (see diagram below).

Healthcare providers have a duty of care to ensure that appropriate governance arrangements are in place and are managed effectively. The Health Technical Memorandum series provides best practice engineering standards and policy to enable management of this duty of care.

It is not the intention within this suite of documents to unnecessarily repeat international or European standards, industry standards or UK Government legislation. Where appropriate, these will be referenced.

Healthcare-specific technical engineering guidance is a vital tool in the safe and efficient operation of healthcare facilities. Health Technical Memorandum guidance is the main source of specific healthcare-related guidance for estates and facilities professionals.

The core suite of nine subject areas provides access to guidance which:

- is more streamlined and accessible;
- encapsulates the latest standards and best practice in healthcare engineering, technology and sustainability;
- provides a structured reference for healthcare engineering.

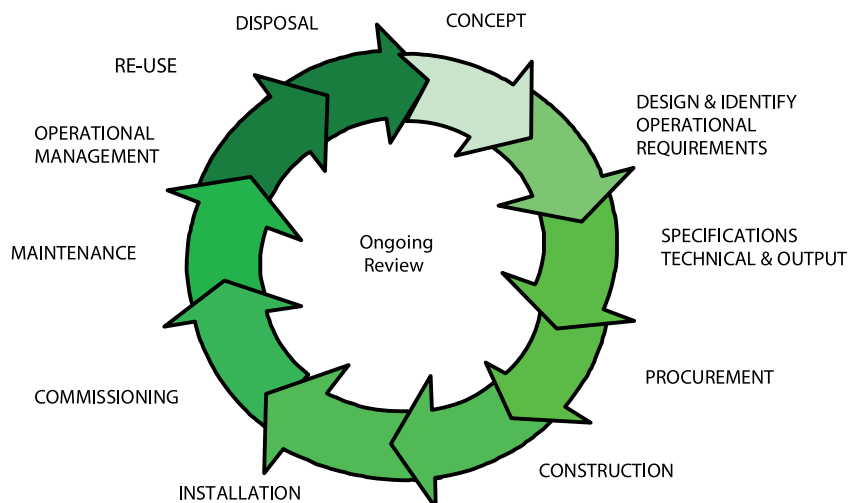

Figure 1 Healthcare building life-cycle

## Structure of the Health Technical Memorandum suite

The series contains a suite of nine core subjects:

Health Technical Memorandum 00  
Policies and principles (applicable to all Health Technical Memoranda in this series)

Choice Framework for local Policy and Procedures 01  
Decontamination

Health Technical Memorandum 02  
Medical gases

Health Technical Memorandum 03  
Heating and ventilation systems

Health Technical Memorandum 04  
Water systems

Health Technical Memorandum 05  
Fire safety

Health Technical Memorandum 06  
Electrical services

Health Technical Memorandum 07  
Environment and sustainability

Health Technical Memorandum 08  
Specialist services

All Health Technical Memoranda are supported by the initial document Health Technical Memorandum 00 which embraces the management and operational policies from previous documents and explores risk management issues.

Some variation in style and structure is reflected by the topic and approach of the different review working groups.

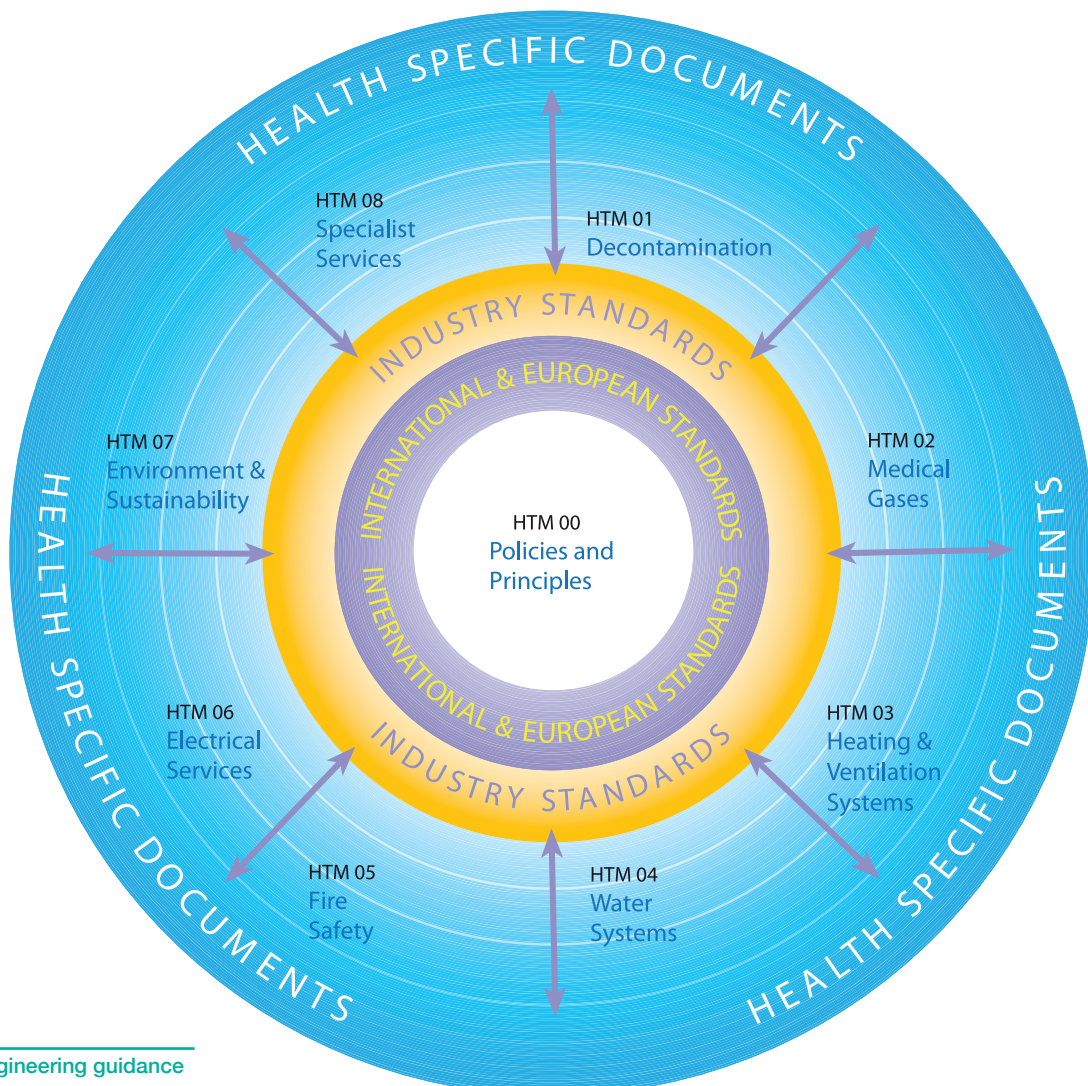

Figure 2 Engineering guidance

DH Estates and Facilities Division wishes to acknowledge the contribution made by professional bodies, engineering consultants, healthcare specialists and NHS staff who have contributed to the production of this guidance.

## Other resources in the DH Estates and Facilities knowledge series

### Health Building Notes

Health Building Notes give best practice guidance on the design and planning of new healthcare buildings and on the adaptation/extension of existing facilities.

They provide information to support the briefing and design processes for individual projects in the NHS building programme..

All Health Technical Memoranda should be read in conjunction with the relevant parts of the Health Building Note series.

### Activity DataBase (ADB)

The Activity DataBase (ADB) data and software assists project teams with the briefing and design of the healthcare environment. Data is based on guidance given in the Health Building Notes and Health Technical Memoranda.

For ADB technical queries only, contact the ADB Helpdesk. Telephone number: 01939 291684; email: [support@talonsolutions.co.uk](mailto:support@talonsolutions.co.uk)

For new ADB customers and licence renewals only, email: [adblicencerenewals@dh.gsi.gov.uk](mailto:adblicencerenewals@dh.gsi.gov.uk)

### How to obtain publications

**Health Technical Memoranda** are available from the UK Government's website at: <https://www.gov.uk/government/collections/health-technical-memorandum-disinfection-and-sterilization>

**Health Building Notes** are available from the same site at: <https://www.gov.uk/government/collections/health-building-notes-core-elements>

# Executive summary

This is the 2015 edition of Health Technical Memorandum (HTM) 05-02 – ‘Guidance in support of functional provisions (Fire safety in the design of healthcare premises)’. The document has been revised to reflect changes in legislation, guidance, the structure of the NHS, and government policy and direction on health and social care. A summary of major changes since previous editions is provided at the end of this Executive Summary.

This 2015 edition supersedes all previous versions of HTM 05-02.

## Scope

HTM 05-02 and the series of which it is part provide specific guidance on fire safety in the design of new healthcare premises and major new extensions to existing healthcare premises. While not intended to cover every possible scenario, the standards and principles it advocates recognise that fire safety in healthcare premises is dependent on the interaction between physical fire precautions, the dependency of the patient, the fire hazards and the availability of sufficient and appropriately trained staff to safely evacuate patients in a fire emergency.

The guidance is applicable to all premises regulated by the Care Quality Commission (CQC), irrespective of ownership, that provide the following types of service:

<b>CQC Code</b>	<b>Service type</b>
ACS	Acute services
HBC	Hyperbaric chamber services
HPS	Hospice services
LTC	Long-term condition services
MLS	Hospital services for people with mental health needs, and/or learning disabilities, and/or problems with substance misuse
RHS	Rehabilitation services
RSM	Residential substance misuse and treatment/rehabilitation services
DTS	Doctors' treatment services
DSS	Diagnostic and/or screening services
UCS	Urgent care services

HTM 05-02 should allow the current statutory regulations to be applied sensibly within a framework of understanding and if applied correctly, will satisfy all the requirements of Part B of Schedule 1 of the 2010 Building Regulations.

Dependent on the requirements, this document should also be read in conjunction with the



relevant HTMs and Health Building Notes (HBNs).

## Aim

The aim of HTM 05-02 is to ensure that everyone concerned with the management, design, procurement and use of the healthcare facility understands the requirements of fire safety in order to ensure optimum safety for all who are present in the building. Only by having knowledge of these requirements can the organisation's board and senior managers understand their legal duties to provide safe, efficient, effective and reliable systems which are critical in supporting direct patient care.

By following this guidance and applying it to the particular needs of their local healthcare organisation, boards and individual senior managers should be able to demonstrate compliance with their responsibilities.

## Users of the guidance

The guidance is aimed at a wide range of users including:

- Providers of NHS-funded healthcare and operating facilities in England;
- Design teams, including architects and engineers;
- Local building control authorities and approved inspectors; and
- Fire and rescue services.

Commissioners of NHS-funded health and care expect that the facilities to which they refer patients will provide a safe, caring environment that aids a patient's recovery and does not expose them to undue risk. Documented evidence that shows compliance with this guidance should provide supporting material to underpin evaluation within the NHS Premises Assurance Model (NHS PAM) and provide confidence of standards to the board of directors and the Care Quality Commission (CQC).

## Structure

The guidance in HTM 05-02 has been restructured to reflect the requirements of Part B of Schedule 1 of the 2010 Building Regulations:

- [Chapter 1](#) provides an overview of the application of HTM 05-02.
- [Chapter 2](#) describes the principles of fire safety in healthcare premises.
- [Chapter 3](#) describes the requirements to meet B1 – Means of warning and escape.
- [Chapter 4](#) describes the requirements to meet B2 – Internal fire spread (linings).
- [Chapter 5](#) describes the requirements to meet B3 – Internal fire spread (structure).
- [Chapter 6](#) describes the requirements to meet B4 – External fire spread.
- [Chapter 7](#) describes the requirements to meet B5 – Access and facilities for the fire and rescue service.

## List of major changes since the 2007 edition

- [Chapter 1](#) recognises the role of the Care Quality Commission in regulating NHS-funded care and limits the application of HTM 05-02 to premises providing specific regulated services types; the guidance on consultation has been expanded and the need to prepare fire safety information to comply with Regulation 38 of the Building Regulations and the Regulatory Reform (Fire Safety) Order emphasised.
- The glossary of terms has been moved to [Appendix A](#).
- [Chapter 2](#) (previously Chapter 3) now includes comprehensive guidance on the designing for fire safety in premises providing in-patient mental health services and in-patient accommodation for people with learning disabilities.

- [Chapter 3](#) combines guidance on detection and alarm, and means of escape, and includes revised guidance on the provision and use of escape lifts.
- [Chapters 4, 5, 6 and 7](#) provide guidance that was previously in Chapter 6 of the superseded document and include a number of technical changes particularly in relation to fire hazard rooms and the location and operation of fire dampers, and fire and smoke dampers.
- The guidance on access and facilities for the fire rescue service is essentially unchanged.

# Policy and regulatory overview

This section of guidance provides an overview of the policy and regulatory framework relevant to HTM 05-02.

## Assurance of estates and facilities

One of the government's key priorities is delivering better health outcomes for patients.

The quality and fitness-for-purpose of the healthcare estate is vital for high-quality, safe and efficient healthcare, and this document sets out the general principles of fire safety used in the construction of the healthcare estate.

Quality and fitness-for-purpose of the estate are assessed against a set of legal requirements and standards. Adherence to the guidance outlined in this Health Technical Memorandum (HTM) will be taken into account as evidence towards compliance with these legal requirements and standards.

Where the principles of the guidance are not to be followed, organisations should document how expectations are being met by equal and alternative means.

## Care Quality Commission: Essential standards of quality and safety

The Care Quality Commission (CQC) regulates all providers of regulated health and adult social care activities in England. The CQC's role is to make sure health and social care services

provide people with safe, effective, compassionate, high-quality care and to encourage care services to improve.

At the time of preparing this document for publication, registration requirements are set out in the Care Quality Commission (Registration) Regulations 2009 (CQC Regulations) and include requirements relating to:

- safety and suitability of premises;
- safety, availability and suitability of equipment; and
- cleanliness and infection control.

### Note on amendment to the CQC Regulations

New regulations are due to come into effect during 2014 and will apply to all providers of health and social care that are required to register with the CQC.

The CQC is responsible for assessing whether providers are meeting the registration requirements (see the CQC's Guidance about compliance (2010)). Failure to comply with the CQC Regulations is an offence and, under the Health and Social Care Act 2008 (Regulated Activities) Regulations 2010, CQC has a wide range of enforcement powers that it can use if the provider is not compliant. These include the issue of a warning notice that requires improvement within a specified time,

prosecution, and the power to cancel a provider's registration, removing its ability to provide regulated activities.

Outcome 10 of the CQC's 'Guidance about compliance' focuses on the "safety and suitability of premises" and decrees that "people receive care in, work in or visit safe surroundings that promote their wellbeing". HTMs are specifically referenced in the CQC's "schedule of applicable publications" as a means of compliance with Outcome 10.

## Building Regulations

The Building Regulations set out requirements with which individual aspects of building design and construction must comply in the interests of:

- the health and safety of building users;
- energy conservation; and
- access to and use of buildings.

Part B of Schedule 1 of the Building Regulations details the functional requirements to provide for fire safety. Guidance on the application of the regulations is provided in approved codes of practice – 'The Approved Documents'; Approved Document B – Fire Safety (Volume 2 – 'Buildings other than dwelling houses') provides guidance on compliance with fire safety requirements for some of the more common building types.

HTM 05-02 has been prepared in order to provide specific guidance for healthcare premises to demonstrate compliance with Part B of Schedule 1 of the Building Regulations.

## Regulatory Reform (Fire Safety) Order 2005

The Regulatory Reform (Fire Safety) Order 2005 (Fire Safety Order) imposes a general duty to take such fire precautions as may be reasonably required to ensure that premises

are safe for the occupants and those in the immediate vicinity. Responsibility for complying with the Fire Safety Order rests with the responsible person, which for the majority of healthcare organisations will be the employer.

A full explanation of the requirements of the Fire Safety Order is contained in HTM 05-01.

## NHS Constitution

The NHS Constitution sets out the rights to which patients, public and staff are entitled. It also outlines the pledges that the NHS is committed to achieve, together with responsibilities that the public, patients and staff owe to one another to ensure that the NHS operates fairly and effectively. All healthcare organisations will be required by law to take account of this Constitution in their decisions and actions.

Healthcare organisations need to "ensure that services are provided in a clean and safe environment that is fit for purpose, based on national best practice (pledge)".

In order to deliver on this pledge, it specifically advises NHS organisations to take account of:

- national best-practice guidance for the design and operation of healthcare facilities;
- the NHS Premises Assurance Model (NHS PAM).

## NHS Premises Assurance Model

The NHS has developed, with the support of DH, the NHS Premises Assurance Model (NHS PAM), whose remit is to provide assurance for the healthcare environment and to ensure that patients, staff and visitors are protected against risks associated with hazards such as unsafe premises.

Primarily aimed at providing governance and assurance to boards of organisations, it allows organisations that provide NHS-funded care and services to better understand the

effectiveness, quality and safety with which they manage their estates and facilities services and how that links to patient experience and patient safety.

Key questions are underpinned by prompt questions that require the production of evidence. Healthcare organisations should prepare and access this evidence to support their assessment of the NHS PAM.

The model also includes reference to evidence and guidance as a helpful aide-memoire to assist in deciding the level of NHS PAM assurance applicable to a particular healthcare site or organisation.

NHS PAM is designed to be available as a universal model to apply across a range of estates and facilities management services.

For more information on how to use the tool, visit the NHS PAM website.

## Impact from, and adapting to, climate change

Requirements under Part B of the Building Regulations and the guidance in this HTM are made for the purpose of ensuring the health and safety of people in and around buildings.

The Environment Agency publishes guidance on the design and construction of buildings for the purpose of protecting the environment. This includes Pollution Prevention Guidelines (PPG18) on Managing Fire Water and Major Spillages, which seeks to minimise the effects of water run-off from firefighting.

It should be noted that compliance with the Building Regulations does not depend upon compliance with other such guidance.

Healthcare organisations need to be mindful of the Climate Change Act and the resultant measures that need to be taken, particularly with regard to flooding, drought, hot weather and freezing temperatures (for further guidance, see Health Building Note (HBN) 00-07 – ‘Planning for a resilient healthcare estate’).

There are two main areas of focus for action with respect to climate change:

- **Mitigation** – which reduces the impact of business functions on the climate through the lowering of carbon emissions from energy use, the reduction of water consumption, improved efficiency of transport etc. Under the Climate Change Act, the government has set up the CRC Energy Efficiency Scheme, which requires large public and private sector organisations to achieve energy-saving targets.
- **Adaptation** – which requires measures be put in place to minimise the adverse effects of climate change (for example flooding, storms, heatwaves and impact on air quality). With respect to buildings and infrastructure, flooding is identified as the main threat by the current UK Climate Change Risk Assessment. The next update to this assessment is expected in 2017.

All public sector bodies are required by government under the National Adaptation Programme (NAP) to put plans in place to address both the causes and consequences of climate change.

The Sustainable Development Unit (SDU) has promoted the development of a sustainable development management plan (SDMP) by all healthcare provider organisations. Further details can be found on the SDU’s website.

# Contents

<b>Preface</b> .....	v
<b>Executive summary</b> .....	viii
<b>Policy and regulatory overview</b> .....	xi
Assurance of estates and facilities	xi
Care Quality Commission: Essential standards of quality and safety	xi
Building Regulations	xii
Regulatory Reform (Fire Safety) Order 2005	xii
NHS Constitution	xii
NHS Premises Assurance Model	xii
Impact from, and adapting to, climate change	xiii
<b>1. Introduction</b> .....	1
General application	1
Building Regulations	1
Fire safety information	2
Consultation and qualitative design review	3
Alternative solutions	4
Use by competent persons	5
Relationship with Construction (Design and Management) Regulations 2015	5
Fire safety during building operations	5
Certification schemes	5
<b>2. Principles of fire safety in healthcare premises</b> .....	6
Introduction	6
Fire safety philosophy	6
Progressive horizontal evacuation	7
Hospital streets	7
Vertical escape	8
Specific considerations based on patient dependency	8
Healthcare premises in Purpose Group 5 – Assembly and Recreation	10
Facilities providing in-patient mental health services and in-patient accommodation for people with learning disabilities	10
Separation of patient-access areas from other parts of healthcare premises	13
Staffing levels	13

<b>3. Means of warning and escape</b> .....	17
Fire detection and alarm	17
Principles of means of escape	17
Progressive horizontal evacuation	18
Sub-compartmentation	21
Travel distances	22
Hospital streets	24
Width of escape routes	27
Vertical escape	27
Assisted patient evacuation	28
Final exits	31
External escape routes	31
Departments providing intensive care	31
Operating departments	32
Emergency and escape lighting	33
Plant areas	33
Security	34
<b>4. Internal fire spread (linings)</b> .....	35
Roof lights	35
Thermoplastic materials	36
<b>5. Internal fire spread (structure)</b> .....	38
Elements of structure	38
Compartmentation	40
Elements of structure and compartment walls	40
Sub-compartment walls	41
Protected shafts	41
Protected lobbies	43
Fire stopping	44
Fire hazard rooms and areas	44
Ventilation systems	45
Cavity barriers	48
Sprinklers	50
<b>6. External fire spread</b> .....	53
Space separation	53
Surfaces of external walls	55
Surfaces of roofs	55
Junction of walls and low-level roofs	55
Junction of compartment and sub-compartment walls and external walls	57
Additional requirements for car parks	57
<b>7. Access and facilities for the fire-and-rescue service</b> .....	60
Site access	60

Access around the building	61
Access and facilities for the fire service	63
Design and construction of fire-fighting shafts	64
Fire mains	64
Venting of basements	65
<b>Appendix A: Glossary of terms</b> .....	67
<b>Appendix B: Periods of fire resistance</b> .....	71
<b>Appendix C: Doors and doorsets</b> .....	73
Door closers	74
Identification	74
Doors on escape routes	75
<b>Appendix D: Thermoplastic materials</b> .....	76
<b>Appendix E: Construction and fixing of cavity barriers</b> .....	78
<b>Appendix F: Fire behaviour of insulating core panels</b> .....	79
Introduction	79
Fire behaviour of the core materials and fixing systems	79
Design recommendations	80
Specifying panel core materials	80
General	80
<b>Appendix G: Fire drawings</b> .....	81
Provision of drawings	81
Fire drawings	81
<b>Appendix H: Care Quality Commission types of service</b> .....	83
Healthcare services	83
<b>Appendix J: Qualitative Design Review</b> .....	87
<b>Appendix K: References</b> .....	89
<b>Appendix L: Summary of changes to the April 2014 edition</b> .....	94



# 1. Introduction

## General application

**1.1** This Health Technical Memorandum provides recommendations and guidance on the design of fire safety in healthcare premises. It supersedes HTM 05-02 – ‘Guidance in support of functional provisions for healthcare premises’, published in January 2007.

**1.2** The guidance in this document is applicable to premises regulated by the Care Quality Commission (CQC), irrespective of ownership, that provide the following types of service:

### CQC Code Service type

ACS	Acute services
HBC	Hyperbaric chamber services
HPS	Hospice services
LTC	Long-term condition services
MLS	Hospital services for people with mental health needs, and/or learning disabilities, and/or problems with substance misuse
RHS	Rehabilitation services
RSM	Residential substance misuse and treatment/rehabilitation services
DTS	Doctors’ treatment services
DSS	Diagnostic and/or screening services
UCS	Urgent care services

A full definition of services is contained in [Appendix H](#).

**1.3** HTM 05-02 should be used in the design of:

- a. new healthcare buildings;
- b. new extensions to existing healthcare buildings;
- c. those parts of existing healthcare buildings that are used as means of escape from a new healthcare extension;
- d. alterations to existing healthcare buildings;
- e. change of use of an existing building, or parts of an existing building, to healthcare use.

Please note: paragraphs 1.3d and 1.3e apply irrespective of whether the alterations and change of use constitute “building work” as defined by the Building Regulations 2010.

## Building Regulations

**1.4** The purpose of this document is to provide guidance on the minimum standards of fire safety expected in healthcare premises to comply with Part B of Schedule 1 of the Building Regulations 2010. It is a guidance document that recognises the problems special to healthcare and allows the current statutory regulations to be applied sensibly within a framework of understanding. To that end, the following functional provisions are expected to be met:

- B1: To ensure satisfactory provision of means of giving an alarm of fire and a satisfactory standard of means of escape for persons in the event of fire in a building ([Chapter 3](#)).
- B2: To ensure fire spread over the internal linings of buildings is inhibited ([Chapter 4](#)).
- B3: To ensure the stability of buildings in the event of fire; to ensure that there is a sufficient degree of fire separation within buildings and between adjoining buildings; to provide automatic fire suppression where necessary; and to inhibit the unseen spread of fire and smoke in concealed spaces in buildings ([Chapter 5](#)).
- B4: To ensure external walls and roofs have adequate resistance to the spread of fire over the external envelope, and that spread of fire from one building to another is restricted ([Chapter 6](#)).
- B5: To ensure satisfactory access for fire appliances to buildings and the provision of facilities in buildings to assist fire fighters in the saving of life of people in and around buildings ([Chapter 7](#)).

**1.5** Health Technical Memorandum 05-02 should be used as guidance on fire safety in all parts of healthcare buildings, classed as Purpose Group 2a – Residential (Institutional),<sup>1</sup> including departments or areas providing ancillary services which are planned as an integral part of a healthcare building. The guidance it contains follows the structure of the requirements set out in Part B Schedule 1 of the Building Regulations.

**1.6** Some of the premises listed in [paragraph 1.2](#) above may be classed as Purpose Group 5 – Assembly and Recreation; for these premises the application of HTM 05-02 should be limited to those measures necessary to provide a safe patient environment for the time necessary to effect an evacuation. Such measures should be

appropriate to the needs of the relevant persons in the building and their levels of dependency; additional guidance is provided in [paragraphs 2.33–2.36](#).

## BS 5588

**1.7** HTM 05-02 refers to the guidance contained in parts of the BS 5588 series of standards as a means of showing compliance with the requirements of Part B (Fire safety) of Schedule 1 to the Building Regulations. In doing so the Department of Health follows the practice adopted by the Department of Communities and Local Government (DCLG) in relation to Approved Document B and references to BS 5588 remain part of HTM 05-02 until such time that it is next revised.

**1.8** Where designers elect to follow the relevant guidance in BS 9999 they will need to satisfy themselves and the building control body that this guidance adequately addresses the requirements of Part B. It is strongly recommended that in such cases designers discuss their proposals with the building control body before starting work.

**1.9** Withdrawn BS standards are readily available from:

The BSI Knowledge Centre  
British Standards Institution  
389 Chiswick High Road  
London, W4 4AL  
Email: [knowledgecentre@bsigroup.com](mailto:knowledgecentre@bsigroup.com)  
Tel: +44 (0)20 8996 7004

## Fire safety information

**1.10** Regulation 38 of the Building Regulations requires that where building work is carried out that affects fire safety, and where the building affected will be covered by the Fire Safety Order, the person carrying out the work must provide sufficient information for persons to operate and maintain the building in reasonable safety. This information will assist the eventual owner/occupier/employer to meet their statutory duties under the Fire Safety Order. The exact

---

<sup>1</sup> As defined in Approved Document B

amount of information and level of detail necessary will vary depending on the nature and complexity of the building's design. Further guidance is provided in paragraphs 1.13–1.19 below.

**1.11** For all healthcare premises covered by the guidance in this document a detailed record of the fire safety strategy, evacuation procedures, patient dependency and staffing levels, together with information on the operation and maintenance of any fire protection measures of the building, will be required.

**1.12** Guidance on the application of the Fire Safety Order to healthcare premises is provided in HTM 05-01.

## Consultation and qualitative design review

**1.13** Health Technical Memorandum 05-02 has been written on the assumption that the premises will be properly managed. Building Regulations do not impose any requirement on the management of a building; however, in developing an appropriate fire safety design for healthcare premises it is essential to consider the way in which it will be managed, as fire safety in healthcare premises relies on well-trained staff to implement a pre-agreed emergency plan; this is especially important where care is provided for dependent or very high dependency patients.

**1.14** A design that relies on an unrealistic or unsustainable management regime cannot be considered to have met the requirements of the Building Regulations.

**1.15** It is therefore essential that the design team have a full understanding of the type of care being provided and the dependency of the patients, and that the client team fully appreciate the constraints imposed by the design on the movement and evacuation of patients, visitors and staff. The design team and approving authorities should not assume that a design which complies with the requirements in

this document will be safe: it needs to be supported by a fully developed emergency plan. This is also a legal requirement imposed by the Fire Safety Order.

**1.16** The preparation of the emergency evacuation plan commences during the design phase and should be developed through the user consultation process. It is important to stress that in relation to the design of appropriate fire precautions, each type of clinical service will present its own unique set of problems which will only fully emerge during the design phase. It is therefore essential that architects and designers, through the client user group consultation process, fully understand and record the fire safety issues associated with the clinical service being provided and the patients being treated.

**1.17** The fire safety measures and the emergency evacuation strategy should be developed and agreed through discussions with:

- a. Client user group – generally involving clinicians, nurses, managers, the fire safety advisor and the local security management specialist;
- b. Design team – architects and engineers;
- c. Fire service representative; and
- d. Building control or approved inspector.

**1.18** For very large and complex projects, it is recommended that a Qualitative Design Review (QDR), as detailed in PD 7974-0:2002, be carried out by a study team involving one or more fire safety engineers, other members of the design team and the client user group. It might also be appropriate to include representatives of approval bodies or the insurers to ensure that their views can be accounted for. Further guidance on the application of QDR to healthcare premises is contained in [Appendix J](#).

**1.19** The outcome of these discussions will be all the information required to support Regulation 38 and should include:

- a. the emergency evacuation plan including all assumptions in relation to:
  - (i) the availability of adequately trained staff to manage an evacuation;
  - (ii) the design of the fire safety systems (such as fire load);
  - (iii) any risk assessments or risk analysis;
- b. all assumptions in the design of the fire safety arrangements regarding the management of the building;
- c. escape routes (including stairs and lifts), escape strategy (for example simultaneous or phased) and muster points;
- d. details of all fire safety measures, including (but not exhaustively):
  - (i) compartmentation, cavity barriers, fire doors, self-closing fire doors and other doors equipped with relevant hardware (for example electronic security locks), and fire and smoke dampers;
  - (ii) automatic fire detection systems, emergency communication systems, CCTV, fire safety signage, emergency lighting, fire extinguishers;
  - (iii) dry or wet risers and other fire-fighting equipment, other interior facilities for the fire-and-rescue service, emergency control rooms, location of hydrants outside the building, and other exterior facilities for the fire-and-rescue service;
  - (iv) sprinkler system(s) design, including isolating valves and control equipment; and
  - (v) smoke-control system(s) (or HVAC system with a smoke-control function) design, including mode of operation and control systems;
- e. any high-risk areas (for example heating machinery) and particular hazards;
- f. as-built plans of the building showing the locations of the above;
- g. specifications of any fire safety equipment provided, including operational details, operator manuals, software, system zoning, routine inspection, and testing and maintenance schedules, together with records of any acceptance or commissioning tests;
- h. any other details appropriate for the specific building; and
- i. for large and/or complex premises, the findings of the QDR.

## Alternative solutions

**1.20** The range of NHS premises providing patient care facilities is extensive, and the guidance in this document may not be appropriate for all types of building. However, it is expected that NHS clients, designers, building control and fire authorities will exercise a degree of judgement based on a full understanding of the problem, taking into account the full implications of the dependency and medical conditions of the patients being treated.

**1.21** This document describes a way of achieving an acceptable standard of fire safety within new and modified healthcare buildings, but it is recognised that there may be other ways of satisfying the functional requirements by adopting a fire safety engineering approach. A fire safety engineering approach that takes into account the total fire safety package can provide an alternative approach to fire safety. If such an approach is used, the responsibility is placed upon those promoting the alternative approach to demonstrate that the alternative

satisfies the functional requirements and fire safety objectives of this document.

## Use by competent persons

**1.22** The guidance in this document has been prepared on the understanding that it will be used by competent persons. For the purposes of this document, a competent person is defined as a person recognised as having sufficient technical training and actual experience, or technical knowledge and other qualities, both to understand fully the dangers involved, and to undertake properly the statutory and Firecode provisions referred to in this Health Technical Memorandum.

## Relationship with Construction (Design and Management) Regulations 2015

**1.23** The purpose of this document is to provide guidance on the fire safety requirements for the completed building. It does not address the risk of fire during the construction work, which is covered by the Construction (Design and Management) Regulations 2015 and the Fire Safety Order. The Health and Safety Executive (HSE) has issued HSG 168: 'Fire safety in construction work' (ISBN: 0 71761 332 1), which provides relevant guidance on fire safety in construction.

**1.24** When the construction work is being carried out on an occupied building, the Fire and Rescue Authority is responsible for the enforcement of the 2005 Regulations in those parts which remain occupied.

## Fire safety during building operations

**1.25** A significant number of fires occur as a result of certain building activities. The site

conduct of contractors should be adequately supervised and controlled. Adequate precautions against fire should be in place, and regular contact with contractors should be maintained to ensure that local fire safety policies are being complied with.

**1.26** It is also important to ensure that – when new buildings are being constructed and handed over in phases – due consideration is given to fire safety after handover. There must be no conflict in the operation of the alarm and detection system between the healthcare-occupied part of the premises and the construction area. Of equal importance is the need to ensure that means of escape is readily available at all times.

## Certification schemes

**1.27** There are many UK product certification schemes. Such schemes certify compliance with the requirements of a recognised document which is appropriate to the purpose for which the material is used. Materials that are not certified may still conform to a relevant standard.

**1.28** Many certification bodies which approve such schemes are accredited by United Kingdom Accreditation Service (UKAS). Since the fire performance of a product, component or structure is dependent upon satisfactory site installation and maintenance, independent schemes of certification and accreditation of installers and maintenance firms can offer confidence in the standard of workmanship provided.

**1.29** Schemes such as those identified above may be accepted by building control bodies as evidence of compliance; however, a building control body may want to establish before work commences that the scheme is adequate for approval purposes.

## 2. Principles of fire safety in healthcare premises

### Introduction

**2.1** In healthcare buildings, particularly in patient access areas, the immediate and total evacuation of the building in the event of fire would be a major logistics exercise and, from a patient safety perspective, not desirable. Patients with restricted mobility, patients who use wheelchairs, and patients confined to bed cannot negotiate escape routes, particularly stairways, unaided. Patients under medication may require staff assistance, and patients who are dependent on electrical/mechanical equipment for their survival cannot always be disconnected and moved rapidly without serious consequences.

**2.2** HTM 05-02 assumes that there are sufficient adequately trained staff on duty in the building to implement the emergency plan. However, while the total evacuation of smaller buildings, or smaller healthcare premises within other buildings, accommodating occupants considered to be independent might be practical, the evacuation of an entire hospital in the event of fire would be an enormous exercise in which patients might be placed at risk due to trauma or their medical condition.

**2.3** Should evacuation become necessary, except for those premises with independent occupants, it should be based on the concept of progressive horizontal evacuation, with only those people directly at risk from the effects of fire being moved. Adopting this approach

ensures that the concept of “inclusive design” has been applied.

**2.4** Healthcare premises accommodating dependent and very high dependency patients should be divided into a series of compartments that may be further divided into sub-compartments which should be constructed to provide the appropriate level of fire safety (see [Chapters 3](#) and [5](#)).

**2.5** Where the evacuation involves very high dependency patients, additional consideration must be given to the distance of travel that might be necessary to reach a place of safety where essential treatment and care could be recommenced.

### Fire safety philosophy

#### Fire evacuation strategy

**2.6** The basic strategy for fire evacuation of dependent and very high dependency patients should be to move them on their bed or in a wheelchair to a safer area (refuge or place of relative safety) on the same floor and then (if required) to evacuate the patients to another floor in the building or to outside.

**2.7** There are three main stages of evacuation:

- a. Stage 1 – horizontal evacuation from the area where the fire originates to an adjoining sub-compartment or compartment;

- b. Stage 2 – horizontal evacuation from the entire compartment where the fire originates to an adjoining compartment on the same floor. Subsequent additional horizontal evacuation to adjacent compartments may be undertaken (thereby putting additional fire resistance between the building occupants and the threat) prior to undertaking vertical evacuation; and
- c. Stage 3 – vertical evacuation to a lower floor, or to the outside.

**2.8** There are three fire conditions when evacuation is necessary or should be considered:

- a. Extreme emergency – where there is an immediate threat to safety from fire or smoke;
- b. Emergency – no immediate threat, but fire or smoke likely to spread from an adjoining area;
- c. Precautionary – no immediate threat to life or safety, but there is a fire on an adjoining floor or in an adjacent building.

**2.9** In extreme emergency situations, the sequence of evacuation should be:

- a. those in immediate danger;
- b. ambulant patients;
- c. the remaining patients who are not ambulant.

## Progressive horizontal evacuation

**2.10** The principle of progressive horizontal evacuation is that of moving occupants from an area affected by fire through a fire-resisting barrier to an adjoining area on the same level, designed to protect the occupants from the immediate dangers of fire and smoke (a refuge). The occupants may remain there until the fire is dealt with or await further assisted onward evacuation by staff to another similar adjoining area or to the nearest stairway. This procedure

should give sufficient time for non-ambulant and partially ambulant patients to be evacuated vertically to a place of safety, should it become necessary to evacuate an entire storey.

**2.11** Active fire protection systems such as automatic fire detection systems, warning systems and fire suppression systems may be incorporated into the building so that the time available for escape is maximised.

**2.12** Patient-access areas should be designed to allow for progressive horizontal evacuation other than in premises where patients fall into the independent category.

**2.13** Areas to which patients have access should not be located on storeys where evacuation in a fire emergency would necessitate travelling up a stairway to a final exit.

## Hospital streets

**2.14** The hospital street provides an essential link between hospital departments and stairways and lifts; it is the main circulation route for staff, patients and visitors. Although many hospitals will be provided with hospital streets, they are not an essential requirement. In smaller hospitals, such as community hospitals, and other healthcare premises, hospital streets are generally not provided.

**2.15** A hospital street is a special type of compartment that connects final exits, stairway enclosures and department entrances. It has two functions from a fire safety aspect:

- a. if the spread of fire within a department cannot be brought under control, the occupants of the department affected may be evacuated via the hospital street to parts of the hospital not affected by the fire; and
- b. it will serve the fire-and-rescue service as a fire-fighting bridgehead.

## Vertical escape

**2.16** Vertical escape in healthcare premises should only be conducted if a fire cannot be controlled within the space of origin and there is additional risk to occupants outside of the fire compartment of origin. This approach to fire safety is adopted due to the additional risks that are present to both staff and patients during the vertical escape phase.

**2.17** In healthcare premises, the practice of designating certain stairways as escape stairways and others as accommodation stairways only is not acceptable, since in an emergency any stairway will be used if necessary. Therefore all stairways should be designed as escape stairways other than those contained wholly within and only serving an atrium.

**2.18** It is recognised that there are many benefits in using lifts to assist with vertical evacuation, especially when evacuating dependent and very high dependency patients, and appropriate guidance is provided in [Chapter 3](#).

## Specific considerations based on patient dependency

**2.19** Firecode has three classifications for patient dependency:

- **Independent** – patients are considered to be independent if:
  - their mobility is not impaired in any way and they are able to physically leave the premises without staff assistance; or
  - they experience some mobility impairment and rely on another person to offer minimal assistance. This would include being sufficiently able to negotiate stairs unaided or with minimal assistance, as well as being able to comprehend the emergency wayfinding signage around the facility.

- **Dependent** – all patients except those classified as “independent” or “very high dependency”.
- **Very high dependency** – those whose clinical treatment and/or condition creates a high dependency on staff. This will include those in intensive care areas, operating theatres, coronary care etc and those for whom evacuation would prove potentially life-threatening.

### Independent patients

**2.20** Areas containing independent patients or occupants who can escape from a fire unaided do not have such a reliance on horizontal evacuation, and therefore the need for compartmentation both horizontally and vertically is reduced.

**2.21** In most cases, the use of Approved Document B will be sufficient (purpose group 2a, or 5 depending on the type of premises). However, where doubt may exist about the mobility of patients, advice should be sought from clinicians to ensure that no part of patient care or treatment would prevent them from quickly responding in the event of a fire.

**2.22** Based on an assessment of each type of patient care, it may be necessary in some instances to apply the recommendations within this document in addition to those of Approved Document B.

### Note

Although the occupancy of an area may be identified as independent, consideration should be given to the need for patients categorised as dependent or very high dependency who may need to be evacuated through that area. In such circumstances the means of escape provisions should reflect the measures necessary for the evacuation of higher dependency occupants.



## Dependent patients

**2.23** The guidance in this document provides additional guidance above that of Approved Document B, which is necessary to meet the increased dependency of patients who fall within this category (and those within the very high dependency category).

## Very high dependency patients

**2.24** In operating theatres and areas that provide intensive care, any movement or evacuation of patients may be life-threatening; consequently, additional precautions are required to address the implications of:

- a. fire and smoke in a compartment either adjacent or below;
- b. fire and smoke within the department itself.

**2.25** The enclosing of departments with fire-resisting construction and the strategic planning of adjacent compartments goes some way to mitigating the risk. The time required for evacuation is longer, as it is often necessary to move the patient, ventilators, monitoring equipment and support staff as one unit, and the design should seek to maximise the protection to the occupants allowing for extended start-up times.

**2.26** Some of the equipment, such as the ventilator, are integral parts of the anaesthetist's equipment and so are provided with an electrical back-up supply. However, this type of equipment is often large and unwieldy, and the evacuation must be pre-planned, as double doorsets are required to facilitate the efficient movement of ancillary equipment.

**2.27** The aim of any design should be to prevent a fire in an adjacent compartment either on the same storey or on a storey above or below, requiring the evacuation of a intensive care area. The compartmentation and HVAC (heating, ventilation and air-conditioning) systems should be designed so that an

adequate period of time is provided to enable a fire to be detected and extinguished before it threatens occupants.

**2.28** The HVAC systems provided to intensive care areas are designed so that the pressure within the department is maintained at slightly above that of the adjacent areas. In a fire emergency, the continuing operation of these systems will assist in preventing smoke and other products of combustion entering the intensive care area.

**2.29** Although it is accepted that some occupants, because of their condition or treatment, should not be moved, provision must still be made for external evacuation. The need for a vertical movement strategy for such occupants must be recognised, and appropriate measures must be installed to reduce the risk associated with such an action.

**2.30** Protected lobbies are provided to those areas of the premises that require additional means to protect against the movement of smoke. Where risk assessment has demonstrated a need, very high dependency treatment areas should be provided with a lobby, which should be sized appropriately to fully accommodate a bed, the associated ancillary equipment and nursing staff, and should include sufficient additional floor space to allow for any manoeuvring as necessary.

**2.31** Where smoke movement into an area accommodating very high dependency patients has been identified as a potential risk (that is, where no hospital streets have been provided), every door opening in the compartment wall should be provided with a protected lobby, each door of which will provide a minimum period of fire resistance of 30 minutes.

**2.32** Any future change in dependency is likely to result in a significant change to the fire precautions applicable. This applies equally to premises designed for independent patients.

## Healthcare premises in Purpose Group 5 – Assembly and Recreation

**2.33** It is becoming more common for health centres, clinics and GP surgeries to provide facilities for minor invasive investigations or procedures that require the use of a local anaesthetic. These will be DTS and DSS services regulated by the Care Quality Commission – see [Appendix H](#). Generally the procedures will be undertaken in a minor procedure room, or treatment room possibly with an adjacent recovery area where patients may remain under observation until the effects of the anaesthetic have worn off.

**2.34** In many cases the use of an anaesthetic will restrict mobility so that patients will require assistance to escape in the event of a fire. Therefore in DTS and DSS premises the means of escape from relevant areas should be designed so that it is always possible, in the first instance, to escape:

- a. horizontally to a place of relative safety from where further horizontal or vertical evacuation is possible; or
- b. directly to a place of safety at ground level.

**2.35** The place of relative safety should either be a separate 30 minute sub-compartment, or a refuge in an escape stairway that is enclosed in 30 minute fire-resisting construction, either of which should be large enough to accommodate the number of patients who at any one time could reasonably be expected to be receiving or recovering from minor invasive investigations or procedures.

**2.36** It is also strongly recommended that these premises are provided with a fire detection and alarm system that complies with the relevant guidance in the HTM 05-03 Part B.

## Facilities providing in-patient mental health services and in-patient accommodation for people with learning disabilities

**2.37** In this context, an in-patient service is defined as a unit with “hospital beds” that provides 24-hour nursing care. Such a unit may be in a hospital campus or a community setting, and may be provided by the NHS or by independent sector providers.

**2.38** In-patient beds should be distinguished from placements registered for the provision of care, which are provided by local authorities and independent sector providers and registered by the CQC. These provide accommodation, usually in a room in a multiple occupancy facility, and a care/support package funded by health and social services.

**2.39** The guidance in HTM 05-02 applies only to in-patient services and not placements.

**2.40** In-patient mental health services cover the following range of services:

- **Acute in-patient bed** – acute in-patient wards for working age adults (18–65) providing intensive medical and nursing support for patients in periods of acute psychiatric illness.
- **Psychiatric intensive care unit** – a type of psychiatric ward. These wards are secure, meaning they are locked and entry and exit of patients is controlled. Staffing levels are higher, sometimes with 1:1 nursing staffing ratios. They usually receive patients who cannot be managed in an acute ward due to the level of risk the patient poses to themselves or others. In some cases patients may also be referred from prisons or rehabilitation wards. Patients will usually be detained under the Mental Health Act.
- **Forensic services** – this covers high, medium and low secure units, of which

only the last two are covered by HTM 05-02.

- **Low secure services** – are provided for those patients who have long-standing and complex problems who cannot be safely or successfully cared for in an acute ward. Patients will be detained under the Mental Health Act.
- **Medium secure services** – are specially designed to meet the needs of adults with a serious mental illness, who require care and treatment in a secure setting to ensure they are safely managed. In most cases patients in medium security will have committed an offence and present a serious risk to themselves and others, combined with a potential to escape.
- **Recovery and rehabilitation services** – rehabilitation units are provided for adults with severe and enduring mental health problems who have ongoing symptoms and functional impairments and cannot manage independent living, even with support.
- **Child and Adolescent Mental Health Services (CAMHS) Tier 4 in-patient services** – these are defined as highly specialised provision that may be required for children and young people up to the age of 18, who may or may not be detained under the Mental Health Act.
- **Dementia assessment** – the term dementia is used to describe a syndrome that may be caused by a number of illnesses with progressive decline in multiple areas of function, including impairment of memory, reasoning, communication skills and the ability to carry out daily activities. As well as memory impairment, dementia might also include behavioural and psychological symptoms such as depression, psychosis, aggression and wandering.

Further information on all of the above is provided in 'Defining mental health services', published in 2012 by the Mental Health Network of the NHS Confederation.

- **In-patient facilities for people with learning disabilities** – a learning disability affects the way a person understands information and how they communicate; it is not the same as a learning difficulty or mental illness. In-patient assessment and treatment beds are required for people with learning disabilities with complex mental health problems and/or challenging behaviours that cannot be managed in the community. The number of units across the NHS is small.

### Specific fire safety information relating to the above premises

**2.41** Although the range of services provided varies considerably, there are common issues that must be considered to enable appropriate levels of fire safety to be achieved. The ultimate aim is to provide a safe and secure environment where patients can receive care and treatment; however, safety from the effects of fire and maintaining the required levels of security are equally important, and the design of fire precautions and evacuation strategies should not compromise security.

**2.42** Highly trained specialised nursing and clinical staff are always present when the premises are occupied and they will be trained to take the lead role in the evacuation of patients.

**2.43** Should a fire start, it will be necessary to evacuate the sub-compartment of fire origin and the number of staff available will influence the speed of evacuation. Such evacuation may be progressive horizontal evacuation to other compartments or sub-compartments as described in [Chapter 3](#).

**2.44** Patients may exhibit behavioural problems that could impact on the fire and security

measures installed. Patients with an acute mental illness or learning disabilities have a history of generating unwanted fire signals. Tampering with fire doors is commonplace, and special attention must be paid to final exits.

**2.45** The implications of this tampering are an increase in the number of false alarms and the potential for complacency amongst staff to the emergency signal. A security issue may also be created with regard to the control of patients and the possibility of unrestricted egress.

**2.46** The potential to configure the alarm and detection system such that in the first instance only staff receive the alarm, can reduce adverse reactions from patients. A general alarm confined to the compartment or zone would only be activated as the evacuation strategy was implemented. Further guidance is provided in HTM 05-03 Part B.

**2.47** Integration of the alarm and detection system with staff and patient monitoring and location systems can improve response times to alarm situations.

**2.48** For security purposes, it is important that final exits do not release immediately on actuation of the alarm. The release mechanism should form part of the overall strategy for managing the evacuation. This gives control to the staff and increases the security of the facility. Some means of control should be provided such that these doors can be opened by staff, on confirmation of the fire signal, when it becomes necessary to evacuate to a designated (secure) assembly point.

**2.49** Should it become necessary to evacuate an entire facility or part thereof, adequate safe and secure external assembly points should be available.

**2.50** Due to the intended occupancy, evacuation to an external assembly point would be a last resort only.

**2.51** When designing external escape routes that are intended for use by mental health patients, similar considerations to those above

should be considered, with the additional caveat of any security measures required to ensure patient safety.

### Specific design requirements for the above premises

**2.52** Sleeping accommodation should be in a separate compartment from day facilities.

**2.53** Accommodation in compartments providing sleeping accommodation should be limited to:

- a. bedrooms;
- b. bathrooms, WCs etc;
- c. cleaners' room;
- d. a small office for staff on overnight duty (this may be an office or a recess off a circulation route);
- e. linen stores.

**2.54** Where sleeping accommodation is segregated by sex, male and female bedrooms should be in separate sub-compartments.

**2.55** The maximum number of beds in any sub-compartment, including swing beds, should be no more than 10.

**2.56** Where “swing beds” are provided it should be possible to include the swing beds in either sub-compartment.

**2.57** Depending on the patients it may be necessary to maintain segregation during evacuation; where this is the case, the design of evacuation routes should ensure that this is always possible. This will also extend to secure places of safety away from the effects of fire, outside the building.

**2.58** Bedrooms:

- a. All bedrooms should be classed as fire hazard rooms.
- b. It may be necessary to provide the potential for bedroom doors to be locked from the inside. However, if this is

required, they should be easy to open from the inside without recourse to a key. In addition, any locking device used should be easy to open from the outside of the room by means of a standard key issued to all staff.

- c. Where patients have restricted mobility, are elderly or are suffering from dementia, moving the patients on their beds is likely to be the most effective method of evacuation. Where this is the case, the design of evacuation routes should allow for bed evacuation and should be designed either:
- (i) to comply with [Figure 1](#) below; or
  - (ii) the architect or designer should provide evidence to the client, fire officer and building control officer, that their design will permit bed evacuation; or
  - (iii) an alternative method of evacuation should be agreed that fully recognises the restricted mobility of the patients, the limitations of the proposed design and the availability of trained staff to safely manage the evacuation.

**2.59** Where communal bathrooms<sup>2</sup> are provided, these should be designed as fire hazard rooms.

## Separation of patient-access areas from other parts of healthcare premises

**2.60** In addition to the general requirement for progressive horizontal evacuation, healthcare premises should also be designed to minimise the possibility of fires from the non-patient-

access areas affecting the patient-access areas of healthcare premises.

**2.61** Non-patient-access areas, for the purposes of this document only, are divided into the following:

- a. Hazard departments: departments/management units that contain high fire loads and/or significant ignition sources. Hazard departments should be separated by distance from any patient-access areas and should not adjoin them, either horizontally or vertically, unless additional precautions are provided.
- b. Non-hazard departments: departments/management units that do not contain high fire load and/or significant ignition sources. Non-hazard departments may adjoin patient-access areas, either horizontally or vertically, provided they are separated from them by compartment walls and floors.

**2.62** Patient-access areas should always be in different compartments from non-patient-access areas.

**2.63** Areas and departments/management units should be located in accordance with [Table 1](#) below.

## Staffing levels

**2.64** The provision of an adequate number of staff who have received effective fire safety training is the best first line of defence against fire. This is particularly important when levels of activity in the building are reduced. The presence of trained staff who can respond quickly and effectively to any fire emergency is a vital factor in limiting the consequences of a fire, particularly where dependent patients are involved.

**2.65** Article 15 of the Fire Safety Order requires the responsible person to:

- a. produce an evacuation procedure;

<sup>2</sup> Communal bathrooms allow unsupervised access and are distinct from bathrooms, which are normally kept locked, with patients only having access when supervised by staff. The former are generally provided in older premises where patient bedrooms are not provided with full en-suite facilities; the latter are generally provided in premises where patient bedrooms have full en-suite facilities (WC, washbasin and shower).

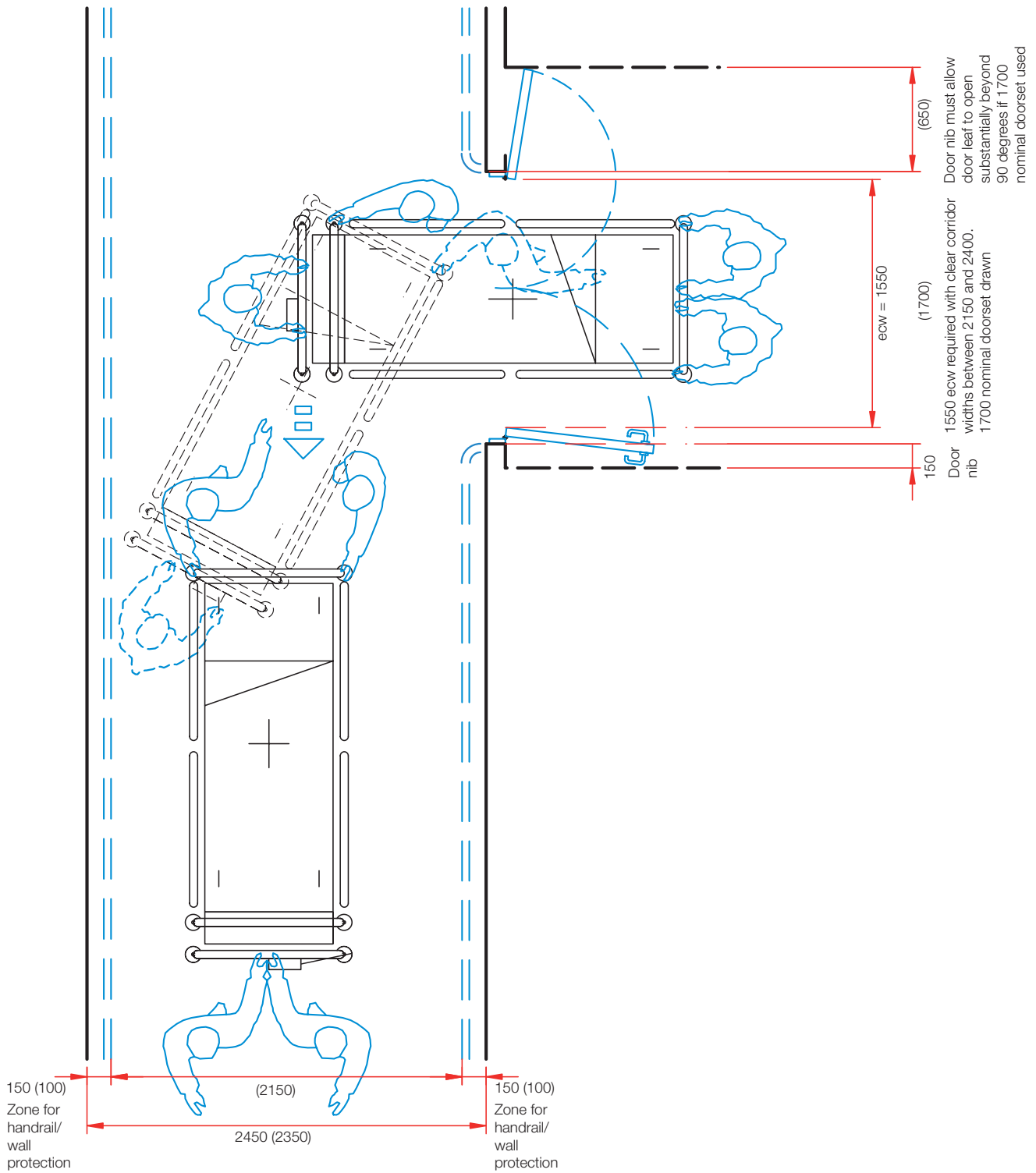

**Figure 1** Widths of doors and corridors to permit bed evacuation

Note: Further guidance is provided in [Chapter 3](#) and Health Building Note 00-04 – ‘Circulation and communication spaces’.

Hazard area or department/ management unit	Separation from patient-access area	
	Normal dependency	Very high dependency
Atrium	Refer to HTM 05-03 Part M	Refer to HTM 05-03 Part M
Boilerhouse (main) <sup>1</sup>	60+ auto suppression	Not allowed
Car park	60+ auto suppression	Not allowed
Central staff change	60	60+ auto suppression
Commercial enterprises	60+ auto suppression	Not allowed
Flammable store	60+ auto suppression	Not allowed
Laundry	60+ auto suppression	Not allowed
Local medical gas stores <sup>2</sup>	60+ ventilation	Not allowed
Main electrical switchgear <sup>3</sup>	60+ auto suppression	Not allowed
Main kitchens	60+ auto suppression	Not allowed
Main stores	60+ auto suppression	Not allowed
Medical records	60	60+ auto suppression
Pathology	60	60+ auto suppression
Pharmaceutical (manufacturing)	60	60+ auto suppression
Refuse collection/incineration	60+ auto suppression	Not allowed
Sterile services department	60	60+ auto suppression
Works	60+ auto suppression	Not allowed

**Key:**

“60” – May be adjacent but should always be separated by 60-minute fire-resisting construction. 60 minutes’ fire resistance may be reduced under certain circumstances (for example if sprinklers are fitted (see [paragraphs 5.12–5.13](#))).

“60+ auto-suppression” – Preferably separate; however, if adjacent, it should be separated by 60-minute imperforate construction together with auto-suppression in the hazard department.

“Not allowed” – should not be located adjacent to very high dependency departments.

**Notes:**

1 Not applicable to small boilers/switchgear in plantrooms serving part of a building.

2 Main medical gas stores should always be located in separate buildings. Health Technical Memorandum 02-01 – ‘Medical gas pipeline systems’ gives guidance. Local medical gas stores should only contain sufficient quantity for daily use.

3 A medium or high voltage transformer, or switchgear room, or battery room serving a whole building or site.

**Table 1 Requirements for the location and fire separation of fire hazard departments from patient-access areas**

- b. have sufficient staff to implement it; and
- c. ensure that staff are adequately trained.

**2.66** The emergency plan (see [paragraphs 1.13–1.19](#)) should detail the fire safety provisions to each patient area and the dependency of the patients within the area being considered. This information will enable the fire safety management procedures to detail the appropriate staffing levels required to undertake the evacuation of the area in the event of a fire; this information should be prepared as the design is being developed to ensure design

assumptions relating to patient evacuation can be realised by the available trained staff.

**2.67** It is the responsibility of management to ensure that adequate numbers of staff will always be available and to devise suitable arrangements to provide for the safe evacuation of all relevant persons in accordance with the emergency evacuation plan. When requested they should be able to demonstrate that staffing levels are adequate to ensure the effective implementation of the emergency plan.

**2.68** Staff should receive training in the methods of patient evacuation appropriate to the dependency of the patients and be familiar with the evacuation procedures at their place of work, and when requested, health service managers should be able to demonstrate that staffing levels are adequate at all times to ensure the safe evacuation of patients.



## 3. Means of warning and escape

### Requirement

Chapter 3 provides guidance to comply with the following Requirement from Part B of Schedule 1 of the Building Regulations 2010.

### Requirement

Means of warning and escape

B1 The building shall be designed and constructed so that there are appropriate provisions for early warning of fire, and appropriate means of escape in case of fire from the building to a place of safety outside the building capable of being safely and effectively used at all material times.

### Fire detection and alarm

**3.1** The design and construction of the building should ensure that fires are detected at the earliest possible opportunity and that suitable warning is then given to the occupants and the emergency services.

**3.2** The provision of adequate means for detecting a fire and raising the alarm is of vital importance. Early detection permits time for orderly evacuation and allows the fire to be tackled at an earlier stage, thus minimising the damage caused. Detection is dependent on both staff observation and the automatic detection and alarm systems.

**3.3** Health Technical Memorandum 05-03 Part B – ‘Fire detection and alarm systems’ provides general principles and technical guidance on the design, specification, installation, commissioning, testing, operation and maintenance of fire alarm systems in healthcare premises. It should be read in conjunction with BS 5839-1 and the relevant parts of BS EN 54.

### Principles of means of escape

**3.4** The design and construction of the building should ensure that at all times, patients, visitors and staff can move away from a fire to: a place of temporary safety inside the building on the same level, from where further escape is possible, ultimately to a place of safety outside the building; or lead directly to the outside.

**3.5** This chapter provides guidance on means of escape by reference to:

- a. the potential for horizontal evacuation, which is achieved by dividing the storey into compartments and sub-compartments;
- b. the height above ground of the treatment area;
- c. travel distances and escape routes;
- d. the provision of an adequate number of stairways to facilitate vertical escape;
- e. emergency and escape lighting.

## Progressive horizontal evacuation

**3.6** The need for progressive horizontal evacuation is discussed in [Chapter 2](#). This principle will be met if the requirements in paragraphs 3.7–3.43 and [Figure 2](#) below are achieved.

**3.7** In a fire emergency, each compartment should be capable of accommodating, as well as its normal occupants, the designed occupancy of the most highly occupied adjoining compartment. This should include space to accommodate beds and medical equipment required to ensure continuity of care.

### Note

For a definition of ground level, see “Height of a building” in the Glossary.

### Floors up to 12 m above ground level with an area of less than 1000 m<sup>2</sup>

**3.8** Every level with a floor area of less than 1000 m<sup>2</sup> and which contains patient-access areas should:

- a. contain no more than 30 patients; and
- b. be divided into a minimum of two compartments.

**3.9** Where a compartment provides sleeping accommodation, the maximum number of beds in the compartment should be no more than 20.

**3.10** On floors above ground-floor level where sprinklers are installed, the fire-resistance of the compartment walls may be reduced to 30 minutes (integrity and insulation), see [paragraph 5.12](#).

### Floors up to 12 m above ground level with an area of more than 1000 m<sup>2</sup>

**3.11** Every level up to 12 m above ground level that has a floor area of more than 1000 m<sup>2</sup> and

which contains patient-access areas should be divided into a minimum of three compartments. One of these compartments may be a hospital street (see [paragraphs 3.37–3.40](#)).

**3.12** Where sprinklers are installed, the fire-resistance of the compartment walls may be reduced to 30 minutes (integrity and insulation), see [paragraph 5.12](#).

### Floors over 12 m above ground level

**3.13** Every level over 12 m above ground that contains patient-access areas should be divided into a minimum of four compartments. Where no hospital street is provided, each compartment should have a minimum floor area of 500 m<sup>2</sup>; where one of the compartments is a hospital street, the area of the hospital street may be less than 500 m<sup>2</sup>.

**3.14** Where sprinklers are installed, the minimum floor area of each compartment required by paragraph 3.13 above may be reduced to 350 m<sup>2</sup>.

### General

**3.15** In a fire emergency each compartment should be capable of accommodating, in addition to its normal occupants, the designed occupancy (including all relevant life support systems) of the most highly occupied adjoining compartment.

### Exits from compartments

**3.16** Exits from compartments should be by way of a circulation space and provided in accordance with the guidance in [Figure 2](#).

**3.17** While it is permissible to locate clinical and some non-clinical departments adjacent to each other, the means of escape through the non-clinical area must be designed to safely accommodate the evacuation of patients (that is, escape routes should be sufficiently wide enough to accommodate beds/trolleys).

**3.18** It is not permissible to evacuate any non-clinical area through a clinical area unless the

1. Storeys up to 12 metres above ground with a floor area of less than 1000 m<sup>2</sup> – a minimum of two exits required as shown below

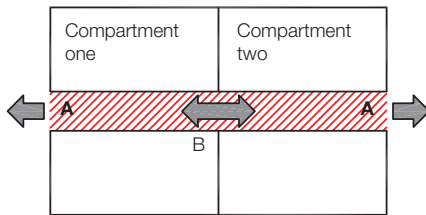

Maximum of 30 patients on each storey

Where compartment provides sleeping accommodation – maximum of 20 beds in each compartment

Exit A – by way of a circulation space to:  
 (i) a stairway; or  
 (ii) a final exit.  
 Exit B – to an adjoining compartment  
 (see also paragraphs 3.16–3.20)

2. Storeys up to 12 metres above ground with a floor area of more than 1000 m<sup>2</sup> – a minimum of three exits required as shown below

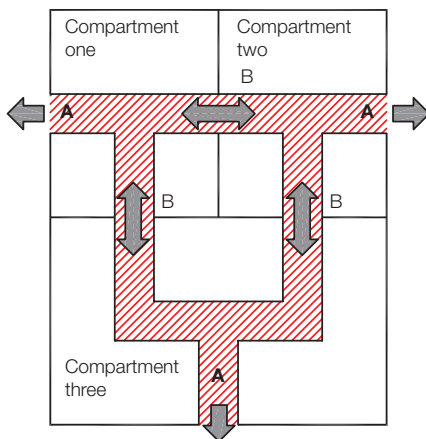

Exit A – by way of a circulation space to:  
 (i) a stairway; or  
 (ii) a final exit.  
 Exit B – to an adjoining compartment  
 (see also paragraphs 3.16–3.20)

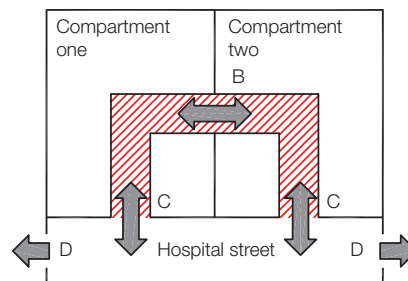

Exit B – to an adjoining compartment  
 (see also paragraphs 3.16–3.20)  
 Exit C – by way of a circulation space to the hospital street  
 Exit D – by way of the hospital street only to a stairway or final exit

3. Storeys over 12 metres above ground – a minimum of three exits required as shown below

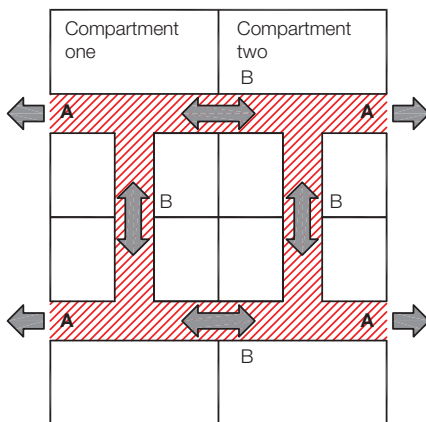

Exit A – by way of a circulation space to:  
 (i) a stairway; or  
 (ii) a final exit.  
 Exit B – to an adjoining compartment  
 (see also paragraphs 3.16–3.20)

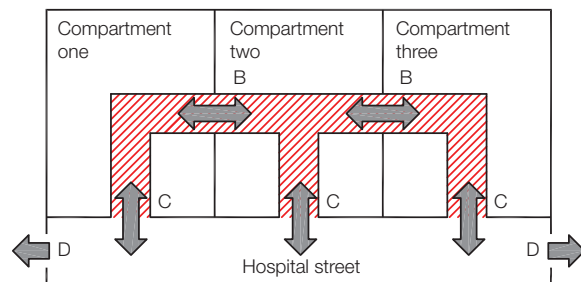

Exit B – to an adjoining compartment  
 (see also paragraphs 3.16–3.20)  
 Exit C – by way of a circulation space to the hospital street  
 Exit D – by way of the hospital street only to a stairway or final exit

Figure 2 Requirements for progressive horizontal evacuation (paragraphs 3.6–3.15)

route through the clinical area is via a circulation route only.

**3.19** From ward bedrooms only, it is acceptable to directly escape to:

- a. an adjacent ward bedroom in an adjoining compartment or sub-compartment; or

- b. a circulation space in an adjoining compartment or sub-compartment (see Figure 3).

**3.20** Where a storey is divided into three or more compartments, the exits from each compartment should be located so that there are at least two alternative exits that provide horizontal escape to adjoining but separate compartments.

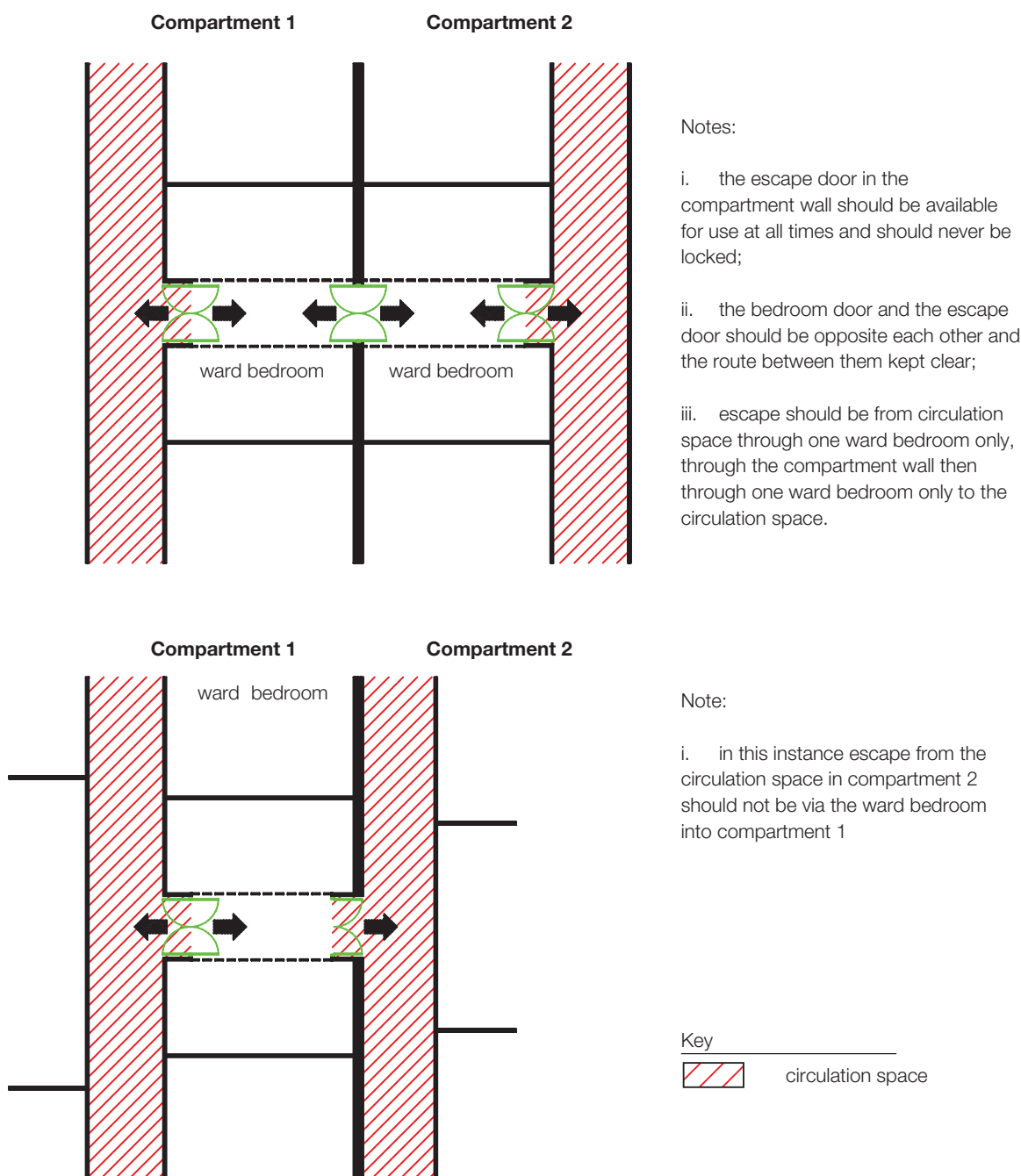

Figure 3 Escape from ward bedrooms

**Note**

It is not possible to give precise recommendations on the location of alternative exits; the aim should be to locate these as far apart as practical and if possible in opposite walls. In the event of a fire, at least one exit should always be available.

**Escape routes over flat roofs**

**3.21** If more than one escape route is available from a storey, or part of a building, one of those routes may be by way of a flat roof, provided that:

- a. the route is for staff only;
- b. the roof should be part of the same building from which escape is being made;
- c. the route across the roof should lead to a storey exit or external escape route;
- d. the part of the roof forming the escape route and its supporting structure, together with any opening within 3 m of the escape route, should be fire-resisting (to a minimum period of 30 minutes if the roof is used solely as an escape route, or to a period provided in [Table 5](#) if the roof is also used as a floor); and
- e. the route should be adequately defined and guarded by walls and/or protective barriers which meet the provisions in Approved Document K.

**Compartment/department relationships**

**3.22** The provision of compartments to facilitate progressive horizontal evacuation should not be looked upon only in terms of means of escape. The management responsibilities, such as the extent of the area under their control, the day-to-day management, fire drills, the management of evacuation etc, will have a significant impact on the design, integrity, size and configuration of compartments. For these reasons it is strongly recommended that the design of a compartment should recognise and integrate

the management and operational arrangements by making the boundaries of compartments coterminous with departmental boundaries.

**3.23** Additional requirements for compartmentation are provided in [Chapter 5](#).

**Sub-compartmentation**

**3.24** The maximum size of a compartment permitted by this document – although appropriate for fire containment (see [paragraph 5.11](#)) – is nevertheless considered too large if the area contains patient-access areas. In the event of a fire, a large number of patients could be overcome by the spread of fire, smoke and toxic gases. Therefore, compartments containing patient-access areas should be divided into smaller sub-compartments to limit the number of patients who may be affected by a fire. Wherever possible, there should be a balance of patients between sub-compartments.

**3.25** A compartment should be sub-compartmented if:

- a. it has a floor area greater than 750 m<sup>2</sup>; or
- b. it contains departments to which more than 30 patients will have access at the same time; or
- c. it contains sleeping accommodation for more than 30 patients.

**Note**

For out-patient departments in hospitals, the floor area may be increased to 1000 m<sup>2</sup> before sub-compartmentation becomes necessary.

**3.26** Sub-compartments should be enclosed by walls having a minimum period of fire resistance of 30 minutes, which should terminate at the underside of:

- a. a compartment floor; or
- b. a roof.

### Exits from sub-compartments

**3.27** Each sub-compartment should be provided with a minimum of two exits to adjoining but separate compartments or sub-compartments.

**3.28** In healthcare buildings, the left-hand arrangement illustrated in Figure 4 is not acceptable.

### Travel distances

**3.29** The distance to adjacent compartments, sub-compartments, hospital streets, stairways and final exits should be limited to ensure that the occupants can escape from the effects of a fire within a reasonable period of time.

### Single direction of escape

**3.30** The maximum travel distance before there is a choice of escape routes should be no more than:

- a. 15 m for in-patient accommodation; or
- b. as specified in paragraphs 3.85–3.87; or

- c. 18 m for all other parts of healthcare buildings.

#### Note

There will be exceptions to these distances in certain parts of healthcare premises buildings (for example aseptic preparation units, operating departments, linac rooms). Where these distances are exceeded, it must be justified in the fire strategy document.

**3.31** Any part of an enclosed escape route that has single direction of escape only, and exceeds 4.5 m, should be protected by 30-minute fire-resisting construction (integrity and insulation). This does not include travel within a room, but applies to “stub” corridors or a small corridor recess.

**3.32** Only glazing that provides a minimum period of fire resistance of 30 minutes (integrity and insulation) may be provided on circulation spaces that give a single direction of escape. Where a sprinkler system is installed, there is no requirement for insulation provided that the

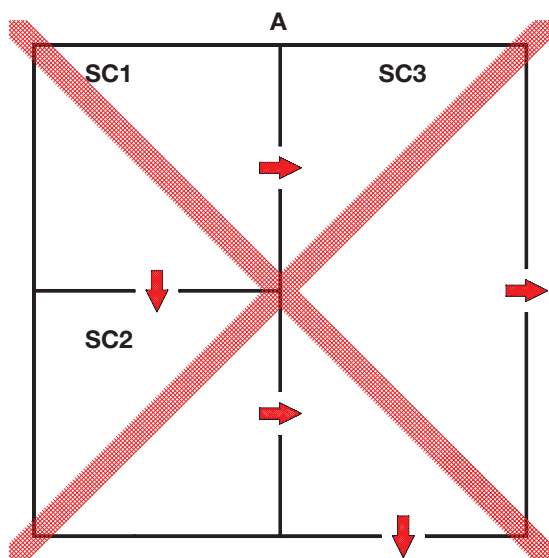

The subcompartmentation in example A is unacceptable since a fire in SC3 would block the exit from SC1 and SC2.

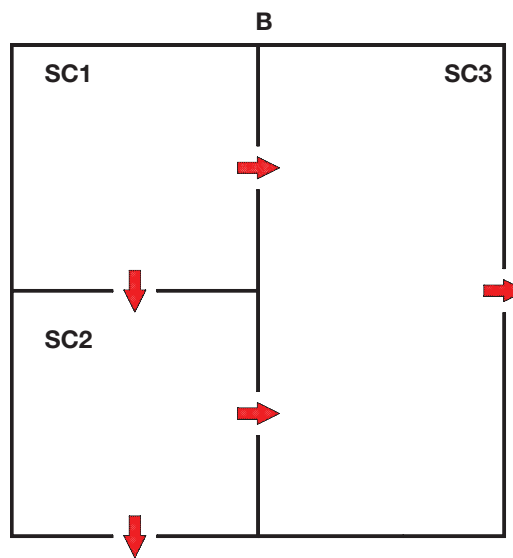

The subcompartmentation in example B is acceptable since a fire in any one subcompartment would not block the safe exit from others.

Figure 4 Exits from sub-compartments

glazing is not the type referred to as “modified toughened”.

**3.33** Escape from an inner room via an access room is permitted provided the access room is not a fire hazard room.

**Total travel distance**

**3.34** The maximum travel distance from any point within a compartment should be no more than 60 m to:

- a. each of two adjoining compartments; or

- b. an adjoining compartment and to a stairway or final exit (see Figure 5).

**3.35** The maximum travel distance from any point within a sub-compartment should be no more than 30 m to:

- a. an adjoining compartment or sub-compartment; or
- b. a stairway or final exit (see Figure 6).

**3.36** Single-direction-of-escape travel distance is an element of maximum travel distance.

**i. Maximum travel distance no more than 60 m to each of two adjoining compartments**

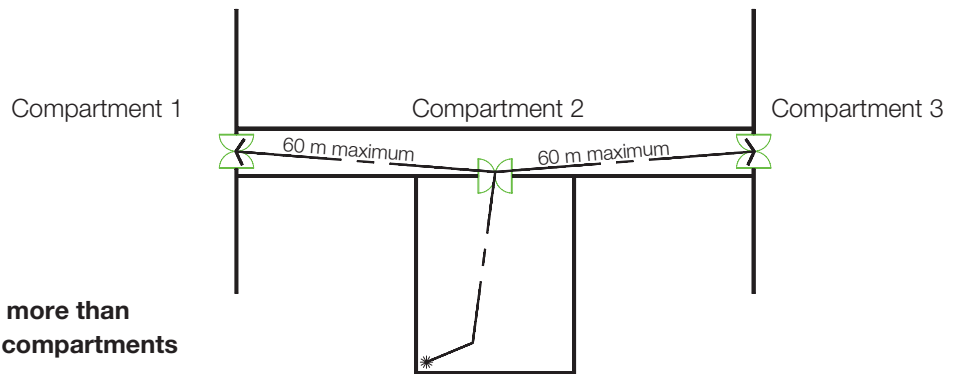

**OR**

**ii. Maximum travel distance no more than 60 m to an adjoining compartment and to a stairway**

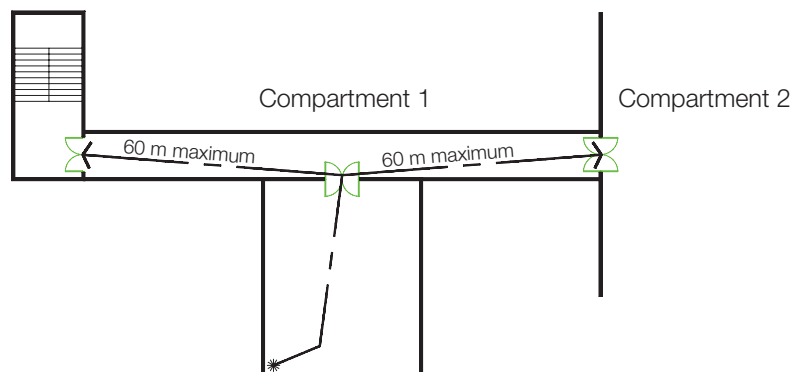
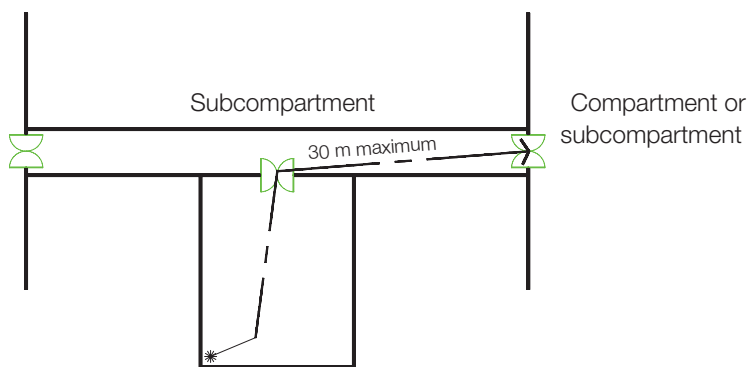

Figure 5 Travel distances within a compartment

i. **Maximum travel distance no more than 30 m to an adjoining compartment or subcompartment**



OR

ii. **Maximum travel distance no more than 30 m to a stairway or final exit**

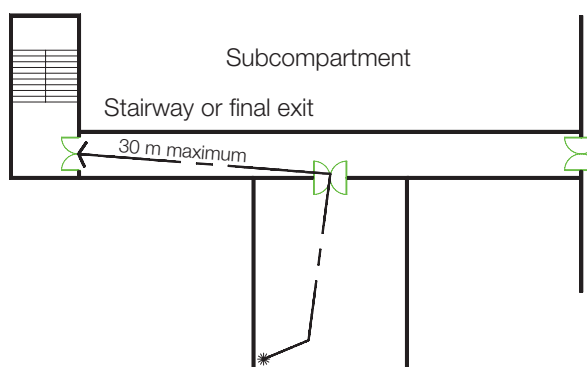

Figure 6 Travel distances within a sub-compartment

## Hospital streets

**3.37** A hospital street should:

- a. be constructed to the same fire-resisting standards as a fire compartment;
- b. have a minimum clear width of 3 m;
- c. be divided into a minimum of three sub-compartments, each with a maximum length of 30 m;
- d. at ground floor – have a minimum of two final exits located:
  - (i) at every extremity of the hospital street;
  - (ii) so that the maximum travel distance between final exits is no more than 180 m measured along the length of hospital street;
- e. at upper levels – have access to a minimum of two stairways each in separate sub-compartments, which are located so that:
  - (i) the maximum distance between stairways does not exceed 60 m;
  - (ii) the maximum single direction of travel within the street does not exceed 15 m;
  - (iii) the distance from a compartment exit to a stairway is no more than 30 m; and
- f. contain no other accommodation except sanitary accommodation (see [Figures 7 and 8](#)).



**i. Basic design**

Minimum width of street 3000 mm  
 Final exit at every extremity

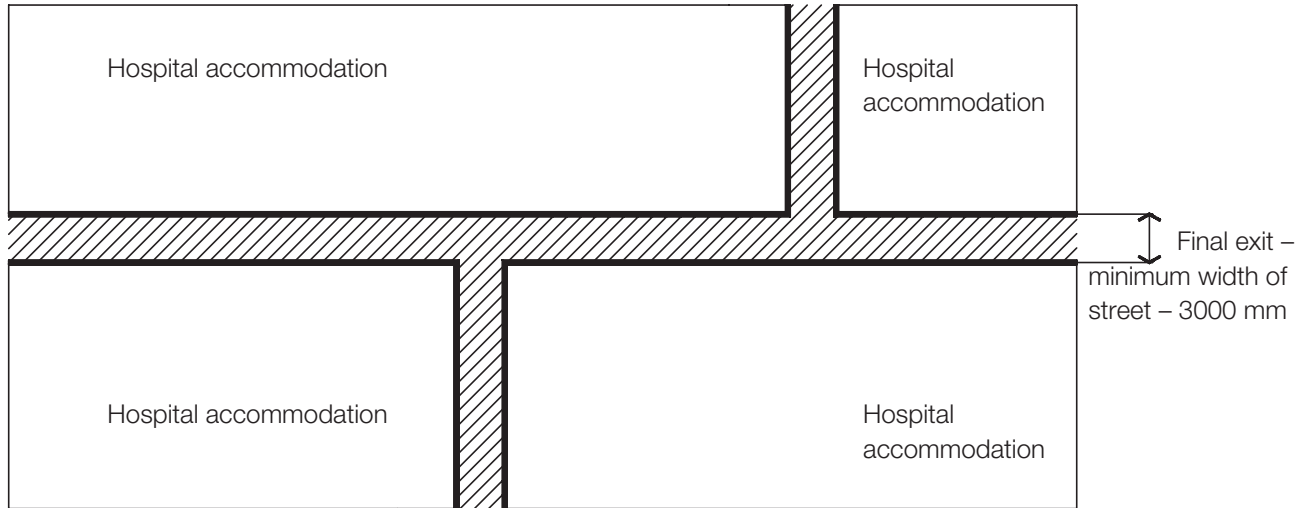

— 60-minute fire-resisting compartment walls

**ii. Basic subdivision**

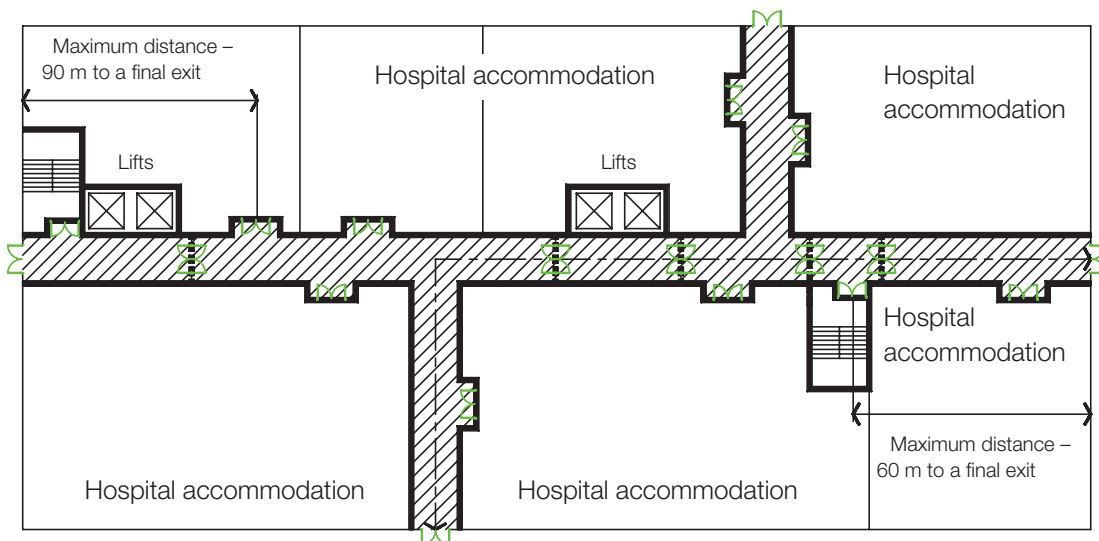

— 60-minute fire-resisting compartment walls  
 - - - - - Maximum travel distance between final exits - 180 m  
 - - - - - Street subdivisions  
 30-minute fire-resisting subcompartment walls

Figure 7 Hospital streets at ground level



**i. Basic design**

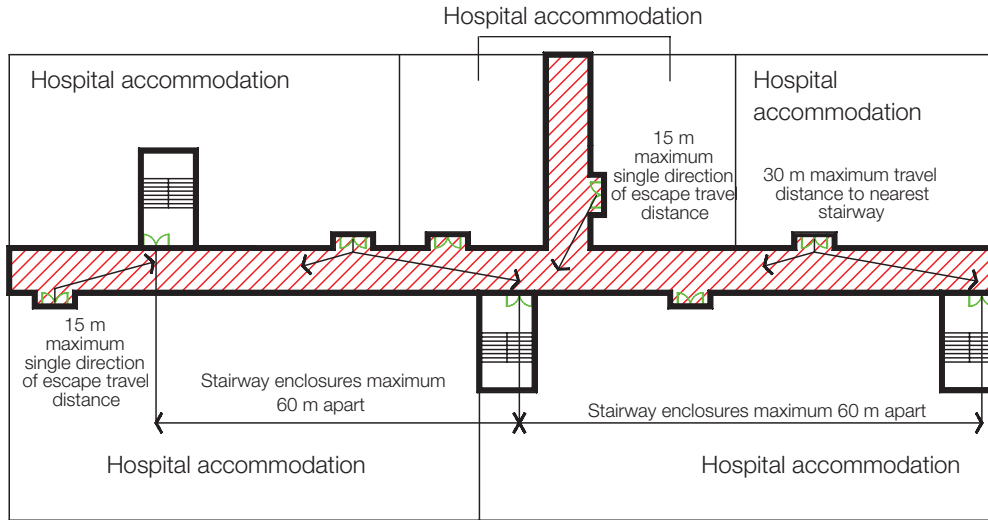

— 60-minute fire-resisting compartment walls

**ii. Basic subdivision**

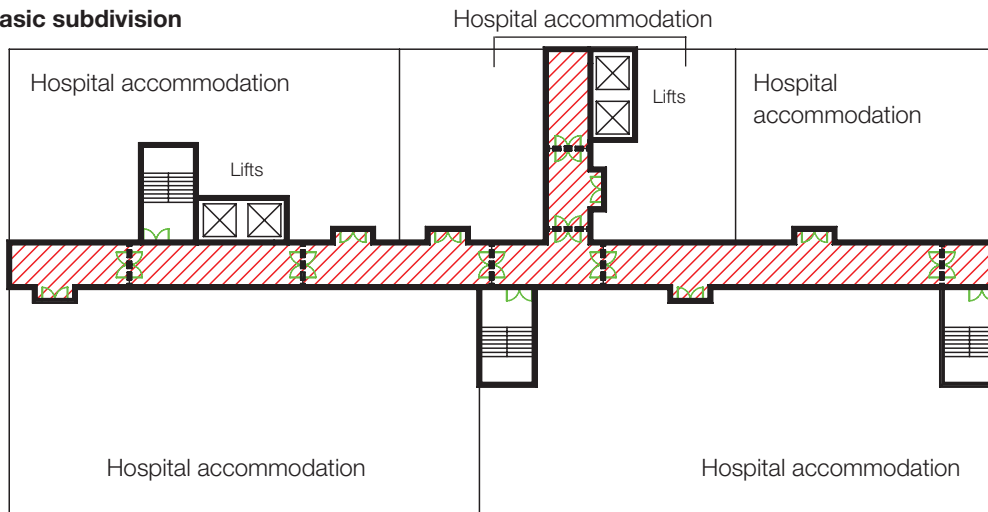

— 60-minute fire-resisting compartment walls

- - - Street subdivision 30-minute fire-resisting subcompartment walls

The arrangement indicated below is not acceptable, as a fire affecting the hatched area of the hospital street would prevent escape from compartments 1 and 2

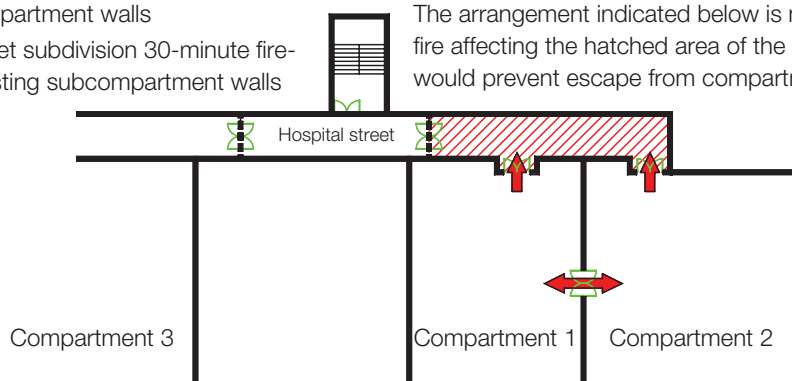

Figure 8 Hospital streets on upper floors

**3.38** Entrances from the hospital street to adjoining compartments should:

- not be located in the same street sub-compartment as entrances to stairways and lift enclosures;
- be located so that an alternative means of escape from each compartment is always possible (see [Figure 8](#)).

**3.39** Stairways should be located so that the maximum travel distance from the exit of the stairway enclosure to a final exit from the hospital street is no more than 60 m. However, it should be noted that there are additional requirements for fire-and-rescue service access into hospital streets, see [paragraphs 7.18–7.20](#).

### Additional requirements for hospital streets with only three sub-compartments

**3.40** On upper storeys, stairways should be provided in two of the three sub-compartments, and the third sub-compartment should be capable of accommodating all the occupants with the associated beds and medical equipment of the largest adjoining compartment.

### Width of escape routes

**3.41** Generally, within departments where beds and patient trolleys are being moved, the width of the circulation spaces required for these activities should be adequate for escape purposes. However, elsewhere, the width of escape routes should be determined by the number of people who would normally be expected to use them in an emergency. In addition, the use of steps should be avoided on circulation routes. Changes in level should be overcome using ramps.

#### Note

Guidance on suitable widths of circulation routes within hospital departments, for operational purposes, is available in Health Building Note 00-04 – ‘Circulation and communication spaces’.

**3.42** In departments and areas where beds or patient trolleys will not be used, the minimum clear width of escape routes should be:

- for up to 200 people – 1200 mm;
- for over 200 people – an additional 275 mm for every additional 50 people.

### Vertical escape

**3.43** In the majority of healthcare premises the practice of designating certain stairways as escape stairways and others as accommodation stairways only is not acceptable, since in an emergency any stairway will be used if necessary. Therefore all stairways, other than those contained within and only serving an atrium, should be designed as escape stairways to permit vertical evacuation by the most appropriate method, see [paragraphs 3.53 to 3.55](#).

**3.44** Most healthcare premises will normally contain an adequate number of stairways due to functional requirements; however, the minimum number of stairways should always meet the provisions in Table 2 below.

Number of patient beds on any one upper storey	Number of stairways
1–100	2
101–200	3
201–300	4
301–400	5

Table 2 Provision of stairways

**3.45** Every building providing healthcare should be provided with a minimum of two stairways. Where hospitals are provided with hospital streets, the stairways should be located within the hospital street. In hospitals not provided with hospital streets, each compartment should have access to a stairway by way of a circulation space – see [Figure 2](#).

**3.46** In all healthcare premises, stairways should be located so that alternative means of escape is always available from every compartment and sub-compartment.

**3.47** External stairways should not be provided for escape purposes from patient-access areas.

**3.48** Stairways should always be remote from each other so that in the event of fire at least one is available for evacuation purposes.

### Escape lifts

**3.49** Where departments providing care and treatment for very high dependency patients or bariatric patients are accommodated on upper floors, at least two escape lifts should be provided. These should be sufficiently remote from each other to ensure that at least one is always available in the event of a fire.

#### Note

It is unrealistic to believe that the total evacuation of occupants from upper floors of multi-storey buildings can be achieved solely by the use of lifts. **Therefore escape stairways will always be required.**

**3.50** The dimensions of escape lifts and lobbies should comply with [Figure 9](#) below.

**3.51** In large buildings or extensive hospital complexes it may be appropriate to utilise non-escape lifts as part of the evacuation strategy. In such instances the lifts should be in a separate fire compartment and separated by distance from the fire-affected part of the building. An assessment will be required to support the use of non-escape lifts in an evacuation; this should consider the guidance of BD 2466 – ‘Guidance on emergency use of lifts or escalators and fire and rescue service operation’.

**3.52** All escape lifts should be designed to comply with the guidance in Health Technical Memorandum 05-03: Part E – ‘Escape lifts’ and BS 5588-8 – ‘Fire precautions in the design, construction and use of buildings: Code of practice for means of escape for disabled people’ and Health Technical Memorandum 08-02 – ‘Lifts’.

## Assisted patient evacuation

**3.53** All stairways to areas that provide sleeping accommodation or contain dependent or very high dependency patients should be designed to permit the evacuation of patients on mattresses (mattress evacuation) or other similar methods. The stair width is not determined by the number of people expected to use the flight in a fire emergency, but by the requirements of mattress manoeuvrability, and therefore the guidance in Approved Document K – ‘Protection from falling, collision and impact’ in relation to landing depths need not be applied.

**3.54** [Table 3](#) and [Figure 10](#) below provide guidance on dimensions to facilitate assisted patient evacuation.

### Width of stairways not intended for assisted patient evacuation

**3.55** Where stairways provide escape from areas used only by independent patients, the width of the stairway should be determined from the guidance in [paragraph 3.42](#).

### All stairways

**3.56** All stairways should terminate at final exit or escape level and:

- a. provide access to the outside; or
- b. discharge to a route from the base of the stairway to the outside, which provides the same period of fire resistance as the protected shaft and which contains no accommodation except that permitted for a protected shaft; or
- c. discharge to a hospital street.

### Additional requirements for stairways

**3.57** Escape stairs should not discharge to an atrium.

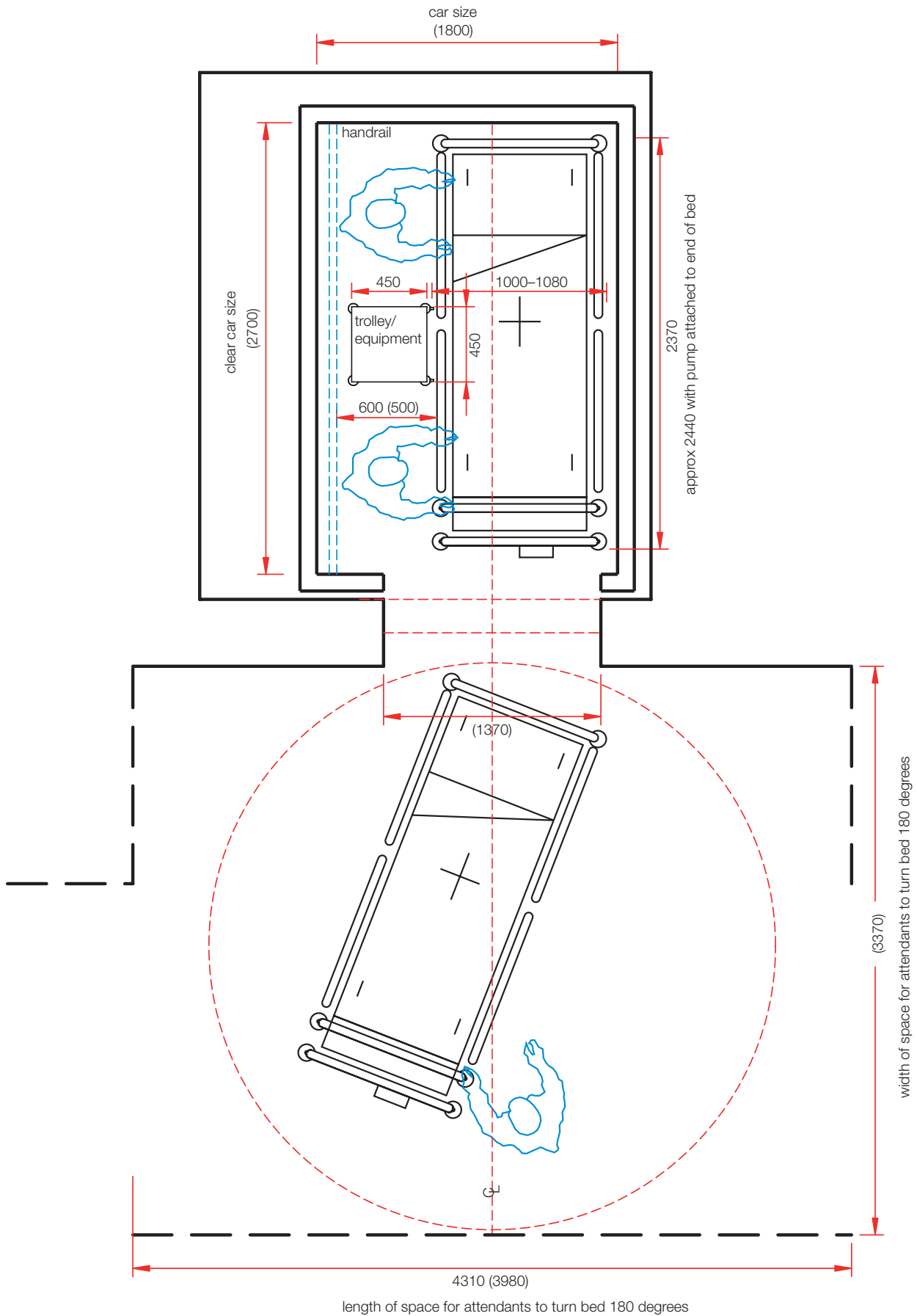

Figure 9 Dimensions of escape lifts and lobbies

A Minimum clear landing width (mm)	B Minimum clear stair width (mm)	C Minimum clear landing depth (mm)	
2800	1100	1950	allows assisted patient evacuation only
2800	1200	1925	
2800	1300	1850	allows assisted patient evacuation and restricted ambulant passing
3000	1400	1750	
3200	1500	1550	
3400	1600	1600*	allows assisted patient evacuation plus ambulant passing
3800	1800	1800*	

\* Stair width is not determined by the number of people expected to use the stairs in a fire emergency, but principally by the requirements of assisted patient evacuation.

The evacuation strategy and the notes below will determine the optimum requirements for stair widths and landing depths.

For a clear landing width of 3400 mm, the minimum clear landing depth for assisted patient evacuation is 1450 mm. 1600 mm is the recommended depth to enable ambulant passing and to equal the stair clear width. See BS 8300.

For a clear landing width of 3800 mm, the minimum clear landing depth for assisted patient evacuation is 1350 mm. 1800 mm is recommended to equal the stair width. See BS 8300.

Table 3 Alternative stair and landing dimensions to facilitate assisted patient evacuation

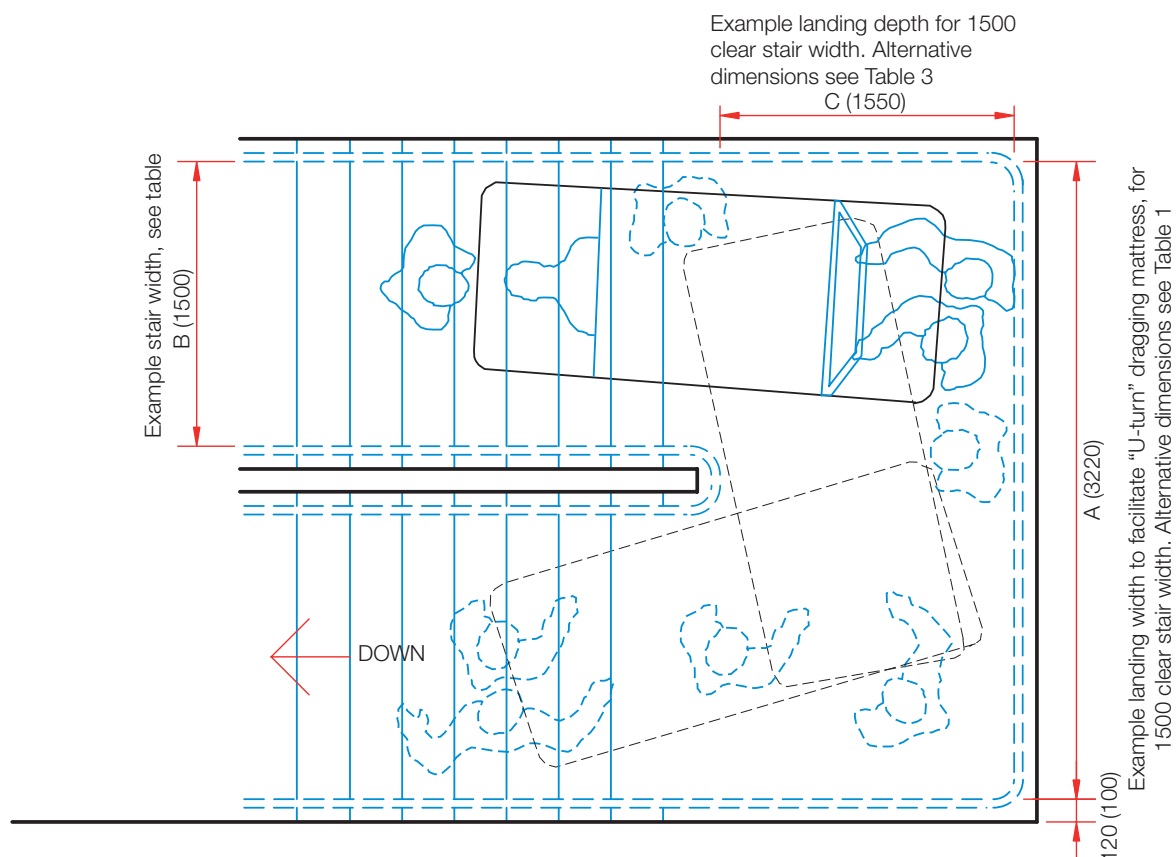

Figure 10 Assisted patient evacuation down a stairway

**Note**

Additional requirements for the enclosure and ventilation of stairways are provided in paragraphs 5.26–5.33.

**Final exits**

**3.58** The design of all exits should recognise the need to maintain the delicate balance between the requirements of means of escape and those of security. It is not possible to provide definitive guidance on this issue; however, any solution should be agreed between the enforcing authorities, the trust management and its local security management specialist.

**3.59** Automatic final exit doors should be freely openable by hand under any condition, including power failure; otherwise, adjacent non-automatic outward-opening doors must be provided.

**3.60** Final exit doors should not be provided with a step and should open onto an area which is level for a distance of at least 1 metre.

**External escape routes**

**3.61** Should it become necessary to evacuate an entire building or part of a building, adequate external assembly positions should be available. Suitable positions may be roadways, hard standings or suitably designed parts of the landscaping.

**3.62** The following points should be considered when designing external escape routes:

- a. the location of assembly positions to permit access for ambulances, while maintaining adequate circulation space for other emergency vehicles;
- b. the provision of adequate artificial lighting;
- c. the provision of adequate paved footpaths and dropped kerbs to the assembly points;
- d. the gradients of external escape routes;
- e. the proximity of external escape routes to the external wall of the building; and
- f. the need to maintain segregation of patients if required by the emergency evacuation strategy – see Chapter 2.

**Departments providing intensive care**

**3.63** In these departments, any movement or evacuation of patients may be life-threatening; consequently, additional precautions are required to address the implications of:

- a. fire and smoke in an adjacent compartment outside the intensive care area;
- b. fire and smoke within the department itself.

**3.64** The aim of any design should be to prevent a fire in an adjacent compartment either on the same storey or on a storey above or below requiring the evacuation of an intensive care area. The compartmentation and HVAC should be designed so that an adequate period of time is provided to enable a fire to be detected and extinguished before it threatens the occupants.

**3.65** With the exception of doors from a hospital street, every door opening in the compartment wall should be provided with a protected lobby, each door of which will provide a minimum period of fire resistance of 30 minutes (integrity). This arrangement will reduce the possibility of smoke ingress from a fire outside the department.

## Sub-compartmentation in departments providing intensive care

**3.66** All departments providing intensive care should be divided into at least two sub-compartments in order to separate the “nursing area” from the “utility area”. The following provides an example:

- Sub-compartment one – staff base:
  - bed areas;
  - clean utility;
  - dirty utility;
  - linen store;
  - status laboratory;
- Sub-compartment two – entrance area:
  - staff changing;
  - staff rest rooms;
  - seminar rooms;
  - cleaners’ store;
  - main equipment store;
  - bulk store;
  - on-call area.

## Heating and ventilation systems

**3.67** The HVAC systems provided to intensive care areas are designed so that the pressure within the department is maintained at a level slightly above that of the adjacent areas. In a fire emergency, the continuing operation of these systems will assist in preventing smoke and other products of combustion entering the intensive care area.

**3.68** In departments providing intensive care, the HVAC systems should be designed so that they continue to operate in a fire emergency. The shutdown of these systems should be controlled from remote panels located either at the department entrance or adjacent to the main fire-alarm indicator panel.

## Operating departments

**3.69** Operating departments, by their very nature, are considered to be very high dependency areas. Evacuation of patients from these departments may be life-threatening; therefore, additional measures should be provided to allow sufficient time to prepare patients for evacuation (see paragraphs 3.70 to 3.73).

**3.70** Consideration should be given to subdividing the operating department to enable local transfer of patients from the immediate threat to a temporary place of safety; this could be achieved by:

- a. sub-compartmenting the operating department with 30 minutes’ fire resistance; or
- b. installing life safety sprinklers (see paragraphs 5.75–5.96) and dividing the operating department with smoke-retarding construction.

### Note

The extent of the sub-division within the operating departments should be risk-assessed, taking into account its size and the number of operating rooms, and operational criticality of the department (that is, business continuity).

**3.71** The design of the sub-compartmentation, the location of smoke-retarding construction and the operation of fire and smoke dampers should not impede the clean air-flow paths and room-air dilution rates, as this may lead to an increased risk of healthcare-associated infections. It is therefore essential that experts in theatre ventilation systems are fully involved in the design of all fire safety measures in operating theatres.

**3.72** Further guidance on the design of specialised ventilation for operating theatres is contained in HTM 03-01 Part A.



**3.73** If practical, plantrooms should be sub-compartmented to separate essential services (for example power and ventilation) serving very high dependency areas from other plant equipment and machinery (for example lift motors, maintenance areas etc).

## Emergency and escape lighting

**3.74** In hospitals, electrical distribution is generally provided by essential and non-essential electrical circuits. To enable services to be maintained, the essential circuits are provided with standby generators that operate when there is a failure of mains electricity serving the site or building. These are designed to provide an emergency electrical back-up supply within 15 seconds of a mains failure.

**3.75** In terms of supporting resilience, additional precautions are necessary; for example, the distribution boards for the essential and non-essential circuits may be in the same location but should be in separate metal cabinets. Likewise, essential and non-essential circuits are normally segregated; however, where this is not possible, essential services cables should be wired in fire-resistant cable. (Note: electrical distribution systems serving life safety and fire-fighting applications as detailed in BS 8519 must always be wired in fire-resistant cable.)

**3.76** In addition to the above, within each hospital department separate circuits are generally provided for circulation spaces. Therefore, failure of a lighting circuit supplying a circulation space should not affect the lighting circuits in the adjacent rooms, and vice-versa.

**3.77** While these features provide a degree of resilience, they do not fully address potential failure modes such as final circuit, distribution board or phase failure. Furthermore, HTM 06-01 recommends that emergency escape lighting in all areas can be operational within 0.5 seconds of interruption to the normal supply, which is not achievable solely through the use of standby generators.

**3.78** Guidance on emergency escape lighting is contained within BS 5266. For healthcare premises buildings, this is supplemented by Health Technical Memorandum 06-01 – ‘Electrical services: supply and distribution’ and the CIBSE guide – ‘Lighting guide LG2: hospitals and healthcare buildings’, which provide additional guidance on hospital emergency lighting and details of the electrical supply required.

**3.79** Emergency escape lighting should be provided to all areas in accordance with BS 5266. Emergency escape lighting includes escape route lighting, open area lighting and high-risk task area lighting, each of which has specific recommendations in terms of location and luminance.

**3.80** All emergency escape lighting should have a minimum duration time of three hours and should incorporate fully automatic network testing facilities.

**3.81** Where possible, central battery or self-contained emergency escape lighting fittings must derive power from essential circuits.

## Plant areas

**3.82** The means of escape from plantrooms should be designed to take account of the fire hazard presented by the equipment or contents of the room and any hindrance to the movement of the occupants (for example low headroom).

**3.83** The escape route should be clear of obstructions and have a clear height of at least 2 m throughout its length.

**3.84** Where a minimum of two exits are provided, the maximum travel distance from any point within a plantroom should not exceed 25 m to the nearest exit from where alternative means of escape are provided. Of this 25 m, the maximum single direction of escape should not exceed 12 m.

**3.85** Where only one exit is provided, the maximum travel distance should not exceed 12 m.

**3.86** Where only one exit is provided, or where there is a danger of people being trapped, alternative means of escape such as ceiling hatches and fixed ladders should be provided.

**3.87** Where the plantroom can be shown to be of very low risk (for example only containing air-handling plant), the distances above may be extended to 25 m and 35 m respectively.

## Security

**3.88** In certain situations it may be essential to maintain a high level of supervision and segregation during an evacuation.

**3.89** In these situations, secure doors that are released automatically on the activation of the fire alarm system may not be acceptable, since:

- a. it would be very difficult for staff to maintain segregation of patients;

- b. patients would be able to disperse, not necessarily following the safest evacuation route or abscond, possibly placing themselves or others at risk; and
- c. it would also be more difficult to establish that everyone had safely escaped from the evacuated area of the building.

**3.90** In areas where security or maintaining patient segregation is important, the staffing levels should be sufficient to allow the operation of a key-operated, or other staff-controlled, means of escape.

**3.91** Any slight delay in opening doors (compared with an automatic system) should be compensated for by the ability of sufficient numbers of well-trained staff team to undertake a controlled evacuation quickly.

## 4. Internal fire spread (linings)

### Requirement

Chapter 4 provides guidance to comply with the following Requirement from Part B of Schedule 1 of the Building Regulations 2010.

### Requirement

Internal fire spread (linings)

B2

- (1) To inhibit the spread of fire within the building, the internal linings shall:
  - a. adequately resist the spread of flame over their surfaces; and
  - b. have, if ignited, a rate of heat release of a rate of fire growth which is reasonable in the circumstances.
- (2) In this paragraph “internal linings” means the materials or products used in lining any partition, wall, ceiling or other internal surface.

**4.1** The surface finish applied to walls and ceilings can contribute to the spread of a fire. Some finishes will rapidly propagate the development of fire by “surface spread of flame”. This not only makes the fire difficult to control, but also provides additional fuel, which will increase the severity of the fire.

**4.2** Surface finishes that can be effectively tested for “surface spread of flame” are rated for performance by reference to the method specified in [Table 4](#) below.

**4.3** Wall and ceiling finishes should meet the classifications in [Table 4](#).

### Roof lights

**4.4** Roof lights should also meet the requirements of [Table 4](#).

**4.5** However, plastic roof lights with a Class 3 rating for surface spread of flame may be used, provided that the limitations imposed by [paragraph 4.9](#) are observed.

Location	National classification	European class
Small rooms (not more than 4 m <sup>2</sup> )	1	C-s3,d2
Circulation spaces	0	B-s3,d2
Other rooms	0	B-s3,d2

**Notes:**

The limitations on surface finishes do not apply to:

- demountable sanitary “back panels” commonly used in health premises to provide access for maintenance behind washbasins, toilets, showers etc; and
- rooms providing a specialist function (for example audiology booths) where other functional criteria dictate the surface finish.

The national classifications do not automatically equate with the equivalent classifications in the European column; therefore, products cannot typically assume a European class unless they have been tested accordingly.

When a classification includes “s3,d2”, this means that there is no limit set for smoke production and/or flaming droplets/particles.

Table 4 Classification of linings

## Thermoplastic materials

**4.6** Thermoplastic materials (see [Appendix D](#)) that cannot meet the performance requirements given in Table 4 may be used in roof lights and lighting diffusers in suspended ceilings if they comply with the requirements in paragraphs 4.10 and 4.12.

**4.7** The guidance on the use of thermoplastic lighting diffusers applies irrespective of whether the lighting diffuser forms part of the ceiling or is attached to the soffit of, or suspended beneath, a ceiling (see Figure 11).

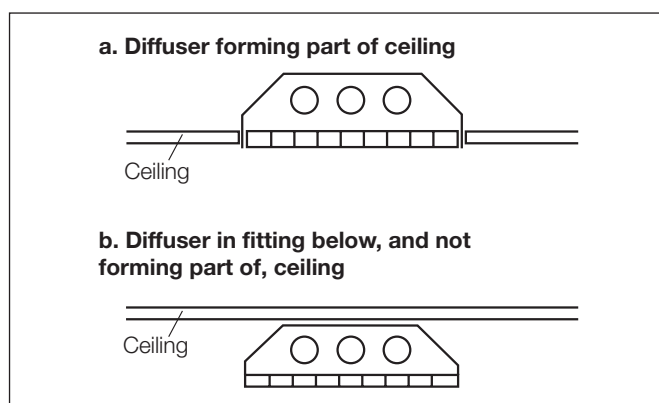

Figure 11 Lighting diffuser in relation to ceiling

**4.8** Thermoplastic roof lights and lighting diffusers with a classification of lower surface of TP(a) (see [Appendix D](#)) may be used in all locations, except stairways, with no restrictions on:

- the maximum area of each diffuser or roof light;
- the maximum total area of diffusers and roof lights;
- the minimum separation between diffusers and roof lights.

**4.9** Thermoplastic roof lights and lighting diffusers with a classification of lower surface TP(b) (see [Appendix D](#)) and roof lights with a Class 3 rating may be used in all areas, with the following restrictions:

- the maximum area of each diffuser or roof light should be no more than 5m<sup>2</sup>;
- the maximum total area of diffusers and roof lights, as a percentage of the floor area of the space in which they are located, should be no more than 15%;
- the minimum distance between roof lights should be not less than 3 m (see [Figure 12](#)).

**4.10** Thermoplastic roof lights with a classification of upper surface TP(b) should not be used.

**4.11** Thermoplastic lighting diffusers should not be used in a fire-resisting ceiling unless they have been satisfactorily tested as part of a ceiling assembly that provides the appropriate fire protection.

**4.12** The minimum distance from a relevant boundary of thermoplastic roof lights with a classification of upper surface of TP(a) should be not less than 6 m.

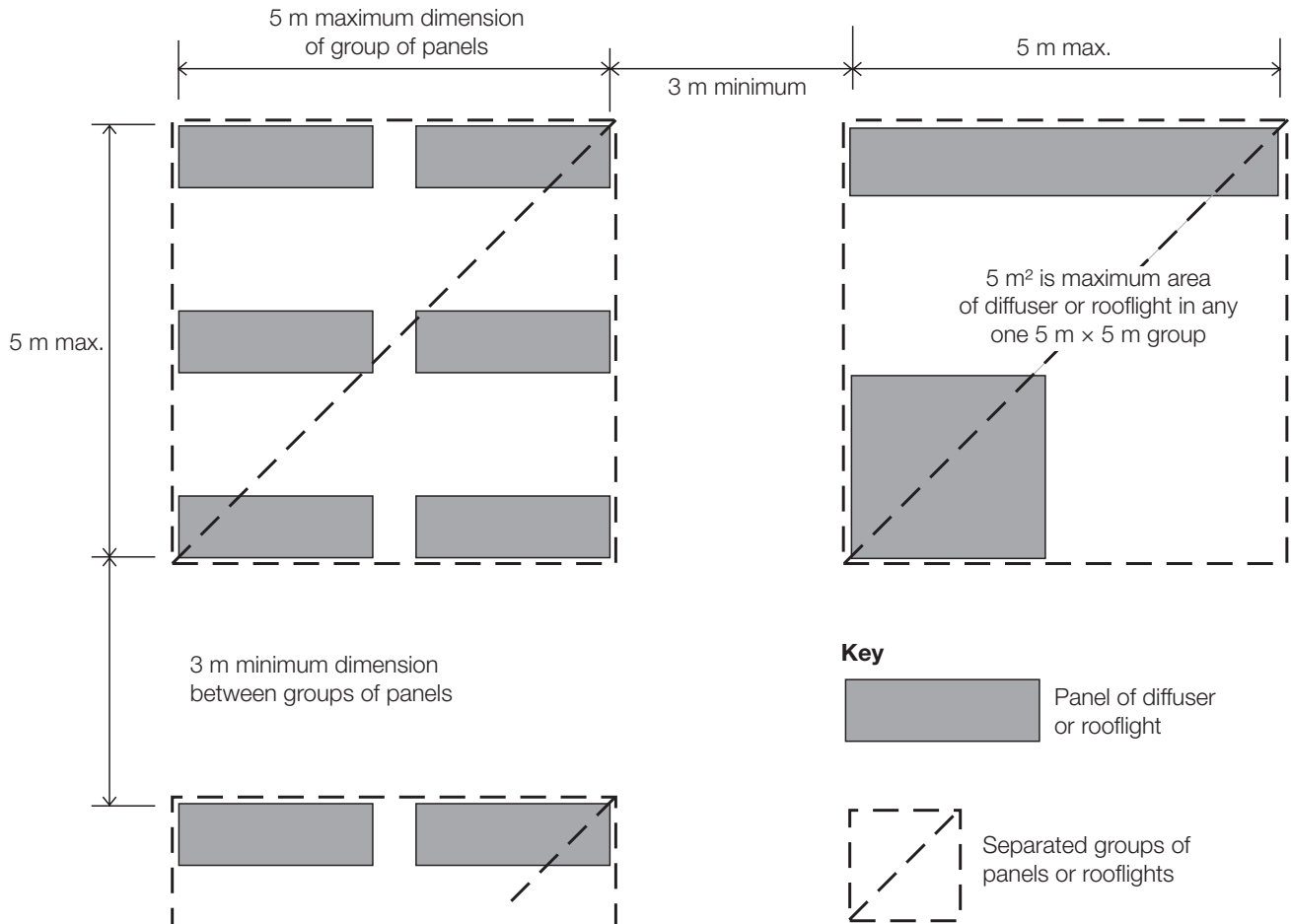

**Notes:**

- Upper and lower surface of suspended ceiling, between plastic panels, to comply with paragraph 6.1 in Approved Document B.
- No restriction on Class 3 roof lights in small rooms.

Figure 12 Layout restrictions on Class 3 rooflights, TP(b) rooflights and TP(b) lighting diffusers

## 5. Internal fire spread (structure)

### Requirement

Chapter 5 provides guidance to comply with the following Requirement from Part B of Schedule 1 of the Building Regulations 2010.

### Requirement

Internal fire spread (structure)

B3

- (1) The building shall be designed and constructed so that, in the event of fire, its stability will be maintained for a reasonable period.
- (2) A wall common to two or more buildings shall be designed and constructed so that it adequately resists the spread of fire between those buildings. For the purposes of this subparagraph a house in a terrace and a semi-detached house are each to be treated as a separate building.
- (3) Where reasonably necessary to inhibit the spread of fire within a building, measures shall be taken, to an extent appropriate to the size and intended use of the building, comprising either or both of the following:
  - a. sub-division of the building with fire-resisting construction;
  - b. installation of suitable automatic fire suppression systems.
- (4) The building shall be designed and constructed so that unseen spread of fire and smoke within concealed spaces in its structure and fabric is inhibited.

### Elements of structure

**5.1** The fire resistance of an element of construction is a measure of its ability to withstand the effects of fire in one or more ways, as follows:

- a. resistance to collapse; that is, the ability to maintain load-bearing capacity (which applies to load-bearing elements only);
- b. resistance to fire penetration; that is, an ability to maintain the integrity of the element; and

- c. resistance to the transfer of excessive heat; that is, an ability to provide insulation from high temperatures.

**5.2** To prevent the premature failure of the structure, the load-bearing elements of the building are required to have a minimum period of fire resistance in terms of resistance to collapse or failure of load-bearing capacity. The purpose of providing the structure with fire resistance is to:

- a. minimise the risk to the occupants, many of whom may still be in a temporary place of safety within the building awaiting evacuation;
- b. reduce the risk to fire-fighters; and
- c. reduce the danger to people in the vicinity of the building.

**5.3** For the purposes of this document, elements of structure are:

- a. a column, beam, or other member forming part of a structural frame;
- b. a load-bearing wall;
- c. a floor.

**5.4** Roof structure and structure that only supports a roof may not require fire-resistance for life safety purposes unless:

- a. the stability of the building depends on the roof; or
- b. the roof serves as a floor, for example a rooftop car park or plantroom; or
- c. the roof is used as an escape route.

**5.5** The minimum period of fire resistance provided by the elements of structure should be as in Table 5.

**5.6** Reductions in periods of fire resistance are permitted only where sprinklers are installed throughout the building. Partial sprinkler coverage will not provide the same extent of protection for structural elements.

**5.7** Partial sprinkler protection can help mitigate localised fire risks in a building and therefore may offer other benefits for the design. A fire engineer should be consulted on a solution that provides enhancements based on partial sprinkler coverage which should be supported by fire engineering evidence.

	Minimum period of fire resistance provided by elements of structure	
	Unsprinklered	Sprinklered
<b>Single-storey healthcare buildings</b>	30 minutes	30 minutes
<b>Healthcare buildings with storeys up to 12 m above ground or basements no more than 10 m deep</b>	60 minutes	30 minutes* (60 minutes in respect of basements*)
<b>Healthcare buildings with storeys over 12 m above ground or basements more than 10 m deep</b>	90 minutes	60 minutes*
<b>Healthcare buildings with storeys over 30 m</b>	Not permitted	90 minutes*
<b>Notes:</b>		
* The reduction in fire resistance is conditional upon a life safety sprinkler system installed and maintained in line with BS EN 12845.		
Elements of structure in relation to basements include the ground-floor slab.		
Where one side of a basement is (due to the slope of the ground) open at ground level, giving an opportunity for smoke venting and access for fire-fighting, it may be appropriate to adopt the standard of fire resistance applicable to above-ground structures for elements of structure in that storey.		
In order to reduce the fire resistance to elements of structure, the whole building must be protected by a sprinkler installation design.		

Table 5 Fire resistance of elements of structure

## Compartmentation

**5.8** The requirement for compartmentation is discussed in [Chapters 2](#) and [3](#). Within patient-access areas, compartmentation is used to divide a storey into places of temporary safety which may be used for refuge. In addition, compartmentation prevents rapid fire spread throughout the building and reduces the likelihood of large fires.

**5.9** For buildings more than one storey in height, all floors should be compartment floors.

**5.10** In healthcare premises, the maximum size of a compartment is generally determined by its use; it is strongly recommended that the size of the management department determines the size of a compartment (see [paragraph 3.22](#)).

**5.11** The maximum area of a compartment should not exceed:

- 2000 m<sup>2</sup> in a multi-storey building;
- 3000 m<sup>2</sup> in a single-storey building.

**5.12** The minimum period of fire resistance (integrity and insulation) provided by compartment walls should be:

- a. for single-storey healthcare buildings – 30 minutes (except where this conflicts with the requirements of [Table 5](#)); or
- b. for all sprinklered healthcare buildings – 30 minutes; or
- c. for all other healthcare buildings – 60 minutes, including those with basements more than 10 m deep and those four storeys or more above ground level.

**5.13** All compartment floors are considered as elements of structure and should satisfy the requirements of [Table 5](#).

## Elements of structure and compartment walls

**5.14** Elements of structure and compartment walls are required to meet the above provisions.

Materials used to meet this provision can be found in the Glossary ([Appendix A](#)) under “Material of limited combustibility”.

**5.15** Where sprinklers are installed throughout the whole building, the requirement for elements of structure and compartment walls to be constructed of materials of limited combustibility does not apply.

## Openings in compartment walls and floors

**5.16** All openings in floors and compartment walls should be protected to provide at least the same period of fire resistance as the compartment structure.

**5.17** To maintain the integrity of compartmentation, openings should be limited to:

- a. doors which have a period of fire resistance not less than that of the compartment structure (that is, integrity performance);
- b. openings for pipes of not more than 160 mm diameter which, if exposed to a temperature of 800°C, will not soften or fracture to the extent that flames or hot gases will pass through the wall of the pipe;
- c. pipes of materials other than those in (b) above of not more than 40 mm diameter;
- d. pipes of any diameter that are provided with a proprietary seal which has been shown by test (for the diameter of pipe proposed) to maintain the fire resistance of the compartment structure;
- e. ventilation ducts that comply with the requirements of BS 5588-9 (see [Figure 16](#));
- f. refuse and laundry chutes of non-combustible construction that are accessed through fire-resisting doors; and
- g. protected shafts.



### Junction of compartment walls with roofs

**5.18** Compartment walls should be taken up to the underside of the roof covering or deck, and fire-stopped to maintain the fire resistance. The compartment wall should also be continued across any eaves cavity.

**5.19** A zone of the roof 1.5 m wide on either side of the wall should have a covering of designation AA, AB or AC (see Approved Document B, Appendix A, paragraph 6) on a substrate or deck of a material of limited combustibility.

#### Note

Double-skinned insulated roof sheeting, with a thermoplastic core, should incorporate a band of material of limited combustibility at least 300 mm wide centred over the wall.

**5.20** As an alternative to paragraphs 5.18 and 5.19 the compartment wall may be extended up through the roof for a height of at least 375 mm above the top surface of the adjoining roof covering.

### Glazing in a compartment wall

**5.21** Any glazing provided in a compartment wall should have the same period of fire resistance (integrity and insulation) as the compartment wall. Glazing should have a permanent, legible mark giving the manufacturer, product name, fire-resistance rating and any requirement for impact safety performance according to BS 6206 or BS EN 12600.

## Sub-compartment walls

### Openings in sub-compartment walls

**5.22** All openings in sub-compartment walls should be protected to provide a minimum period of fire resistance of 30 minutes.

### Glazing in sub-compartment walls

**5.23** Uninsulated fire-resisting glazed screens may only be provided in sub-compartment walls provided they satisfy the following requirements:

- a. the glazing should provide a minimum period of 30 minutes' fire resistance (integrity only);
- b. the area of integrity-only glazing should be limited to a maximum of 1 m<sup>2</sup> in any room.

**5.24** There is no limit on the use of glazed screens that provide a minimum period of fire resistance of 30 minutes (integrity and insulation).

**5.25** Where sprinklers are fitted, there is no limit on the use of glazed screens that provide a minimum period of fire resistance of 30 minutes (integrity only), provided the glass is not of the type referred to as "modified toughened".

## Protected shafts

**5.26** Openings in floors for stairways, lifts, escalators, and pipes and ducts not complying with [paragraph 5.17](#) should be enclosed in a protected shaft that has the same period of fire resistance (integrity, insulation and, where applicable, load-bearing capacity) as the compartment floor (see [Figure 13](#)).

**5.27** The protected shaft should form a complete barrier to fire between different compartments to which the shaft connects and should be constructed from materials of limited combustibility. Where services (pipes, cables, ducts etc) are required to pass through the enclosing structure they should be adequately fire-stopped to maintain the fire resistance of the protected shaft. Where pipes are required to pass through the enclosing structure, they should be designed in accordance with [Figure 14](#).

**5.28** Any internal glazing provided to a protected shaft should have the same period of

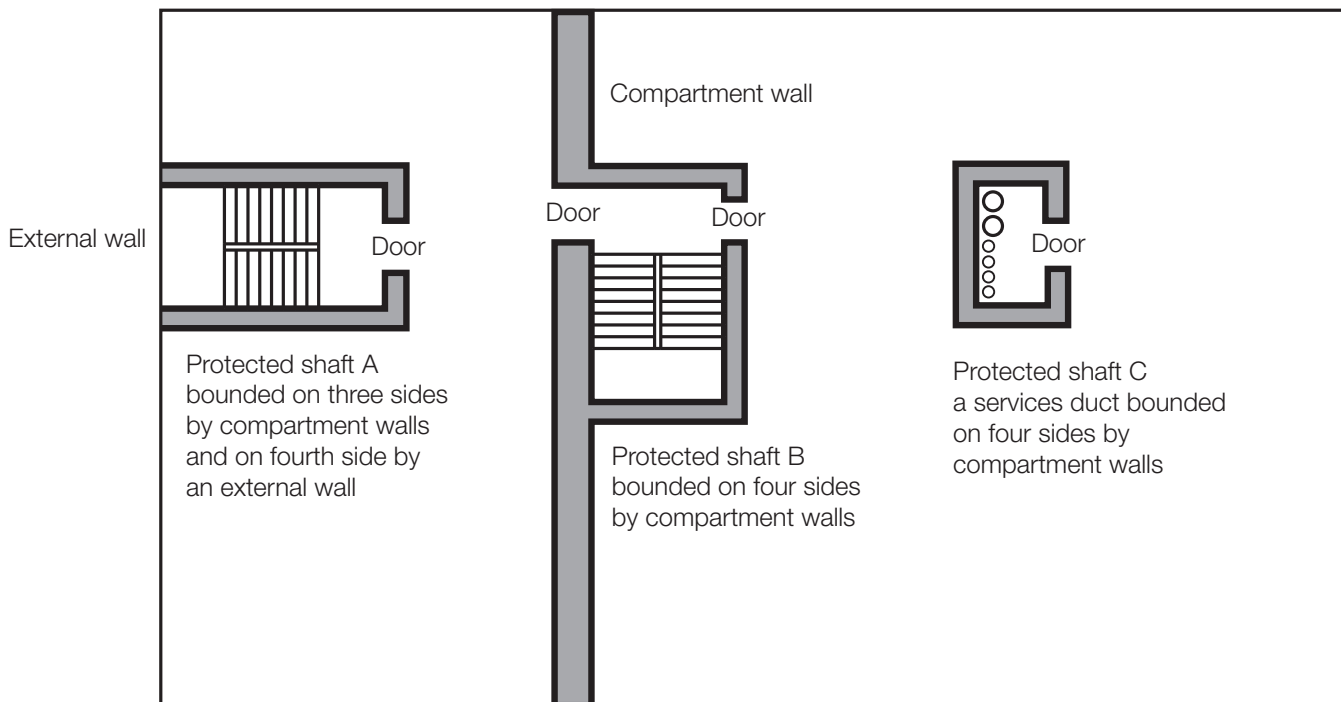

**Note:** The protected shaft should meet the relevant provisions for compartment walls

Figure 13 Protected shafts

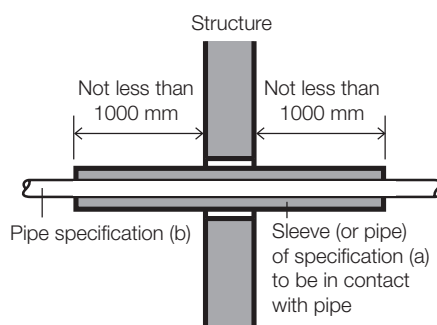

Pipe material and maximum nominal internal diameter (mm)			
	(a) Non-combustible material <sup>1</sup>	(b) Lead, aluminium, aluminium alloy, uPVC <sup>2</sup> , fibre cement	(c) Any other material
<b>Structure enclosing a protected shaft which is not a stairway or lift shaft</b>	160	110	40
<b>Any other situation</b>	160	40	40

Notes:  
 1. Any non-combustible material (such as castiron, copper or steel) which, if exposed to a temperature of 800°C, will not soften or fracture to the extent that flame or hot gas will pass through the wall of the pipe.  
 2. uPVC pipes complying with BS 4514 and uPVC pipes complying with BS 5255.

Figure 14 Pipes penetrating fire-resisting structure

fire resistance (integrity and insulation) as the protected shaft.

**5.29** The use of roof lights over protected shafts used for stairways should be limited to those that provide a Class 1 surface spread of flame on both upper and lower surfaces.

**5.30** The use of protected shafts should be limited to:

- a. stairways;
- b. lifts;
- c. escalators;
- d. chutes;
- e. ducts;
- f. pipes.

**5.31** No accommodation should be included within protected shafts.

**5.32** Pipes conveying oil or gas and ventilation ductwork should not be located in the same protected shaft as a stairway or lift – except pipes conveying oil as part of the operating

mechanism of a hydraulic lift and ventilation ductwork provided for the purposes of pressurising the stairway.

**5.33** Protected shafts containing a stairway should be provided with an opening window, or similar, providing a clear ventilation area of 1 m<sup>2</sup>.

## Protected lobbies

**5.34** Protected shafts for stairways and lifts should be provided with protected lobbies except where they are accessed from a hospital street.

**5.35** Protected lobbies should not be located so that they form part of a through route; that is, they should not be located across a corridor if the corridor continues beyond the protected lobby (see Figure 15).

**5.36** Guidance on the recommended dimensions for internal lobbies is provided in Health Building Note 00-04 – ‘Circulation and communication spaces’. This recommends that where swing doors are used, a minimum clear

**i. stairway accessed from a circulation space (protected lobby required)**

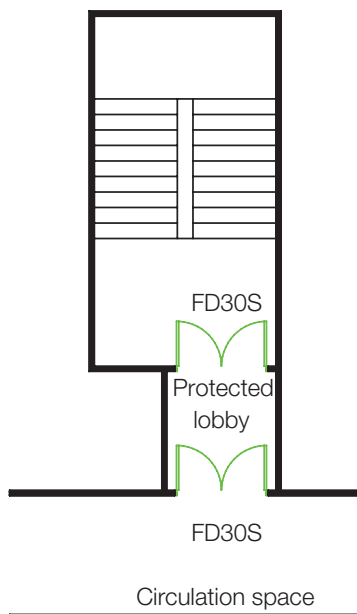

**ii. stairway accessed from a hospital street (protected lobby not required)**

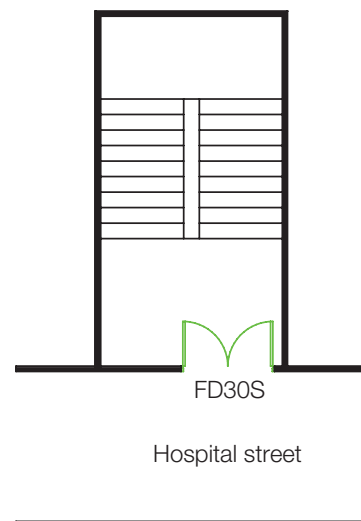

Figure 15 Protected lobbies to stairways

length (that is clear of the furthest point that door(s) will swing into) is provided of:

- a. 1.570 m for general traffic access; and
- b. 4.100 m for bed/trolley access.

**5.37** Protected lobbies should:

- a. be constructed from materials of limited combustibility and have the same fire resistance as the protected shaft; and
- b. contain no other accommodation except that allowed for protected shafts.

### Fire stopping

**5.38** In addition to any other provisions in this document for fire-stopping, joints between fire-separating elements should be fire-stopped and all openings for pipes, ducts, conduits or cables to pass through any part of fire-separating elements should be:

- a. kept as few in number as possible;
- b. kept as small as practicable; and
- c. fire-stopped (which in the case of a pipe or duct, should allow thermal movement).

**5.39** Guidance on the process of design, installation and maintenance of passive fire protection is available in ‘Ensuring best practice for passive fire protection in buildings’ (ISBN: 1 87040 919 1) produced by the Association for Specialist Fire Protection (ASFP).

### Fire hazard rooms and areas

**5.40** For most building types, it is normally required to protect escape routes with fire-resisting walls, ceilings and doors (protected corridors). In healthcare premises this is not considered acceptable, since the excessive number of fire-resisting doors, all fitted with self-closing devices, would be a hindrance to staff and patients during the everyday running of a healthcare building. For this reason, the technique advocated for healthcare buildings is to identify and segregate fire hazard rooms by at least 30 minutes’ fire-resisting construction.

**5.41** Table 6 gives examples of fire hazard rooms. The list is not exhaustive, and the onus rests with the designer to assess the fire risk associated with all rooms to determine the need to enclose in fire-resisting construction.

Chemical stores	Store rooms
Cleaners’ room	Relatives’ overnight stay room
Clothes storage	Ward kitchens
Disposal rooms	Communal bathrooms in mental health premises (see <a href="#">paragraph 2.52</a> )
Hub rooms	Linen stores
Lift motor rooms	Staff on-call rooms
Main staff changing and locker rooms	Patient bedrooms provided specifically for: <ul style="list-style-type: none"> <li>• people with mental health needs</li> <li>• people with learning disabilities</li> </ul>

**Key**

	Doors to these rooms to be kept locked shut
	Door to be fitted with appropriately designed free-swing self-closing devices
	Doors to be fitted with self-closing devices
	Self-closing devices not required.

**Table 6** Examples of fire hazard rooms

**5.42** Fire hazard rooms and areas should be enclosed in 30 minutes’ fire-resisting construction (integrity and insulation). Walls may be terminated at ceiling level provided that:

- a. the ceiling is non-demountable and has a minimum period of fire resistance of 30 minutes when tested (complete with any lighting units) from below in accordance with BS 476 (Parts 20 and 22);
- b. ducts perforating the ceiling are fitted with fire dampers;
- c. conduits, pipes etc perforating the ceiling are fire-stopped and comply with the requirements of [paragraph 5.27](#).

**5.43** Where sprinklers are installed, the need to enclose fire hazard rooms in fire-resisting construction should be risk-assessed.

## Glazed screens

**5.44** Uninsulated glazed screens should not be provided to fire hazard rooms; however, there is no limit on the use of glazed screens that provide a minimum period of fire resistance of 30 minutes when tested to the relevant parts of BS 476 (integrity and insulation) or BS EN 12600.

## Ventilation systems

**5.45** Mechanical ventilation is used extensively in healthcare premises, including specialist systems for primary patient treatment in operating departments, critical care areas and isolation rooms. It is also installed to ensure compliance with quality assurance of manufactured items in pharmacy and sterile services departments and to protect staff from harmful organisms and toxic substances (for example in laboratories).

**5.46** In the event of a fire, large quantities of smoke and toxic gases can be given off, which potentially could be transferred through the ductwork to rooms and areas remote from the fire. Therefore, measures are required to:

- a. limit the spread of fire, smoke and other products of combustion within the ductwork between protected areas;
- b. prevent a breach in the integrity of an enclosing fire-resisting element of construction where penetrated by ductwork.

**5.47** Ventilation systems should be designed and installed to comply with Health Technical Memorandum 03-01 – ‘Specialised ventilation for healthcare premises’ and BS 5588-9.

**5.48** Ventilation systems should not be common to both patient areas and hazard departments. Fresh-air intakes should be positioned to avoid the possibility of the intake of smoke and toxic gases.

## Location and operation of fire and smoke dampers and fire dampers

**5.49** Ventilation ducts should maintain the period of fire resistance of the construction through which they pass; this includes but is not limited to fire hazard rooms, sub-compartments, compartments, cavity barriers and protected shafts.

**5.50** The type of dampers permitted in each form of construction is indicated in [Table 7](#).

**5.51** All dampers should be installed in accordance with the manufacturer’s tested details so that they maintain their integrity against the passage of fire for the required period of fire resistance. They should be adequately fixed into, or to, the construction they are protecting. A damper that is supported only by the ductwork in which it is located, or by timber battens, frames or other methods that do not provide the fire resistance required, is not acceptable.

**5.52** Dampers provided in 30-minute fire-resisting ceilings should be adequately supported either by the ceiling or from the structural soffit. In the ceiling situation, it is also essential to ensure that the integrity of the fire-resisting ceiling is maintained. It is not acceptable to form an opening, install a diffuser or grille and fit a damper above if the gap between the ceiling opening and the damper does not achieve 30 minutes’ fire resistance.

**5.53** Where, due to the specialist nature of the ventilation system, the inclusion of dampers is not recommended, fire rated ductwork will be required. This would typically occur with the provision of fume cupboards, isolation rooms and kitchen extract systems, for example. The fire rated ductwork should meet the same performance requirements of the elements through which it passes and should be installed in accordance with the manufacturer’s tested detail.

	Fire and smoke damper activated by AFD	Fire damper (Thermal activation)	Air transfer grille – cold smoke (activated by AFD)	Air transfer grille (thermal activation)
Compartment floor	✓	X	X	X
Compartment wall	✓	X	X	X
Protected shaft	✓	X	X	X
Sub-compartment wall	✓	X	X	X
Cavity barrier	✓	✓	N/A	N/A
Fire hazard room	✓	✓	✓	X
Door to fire hazard rooms	N/A	N/A	✓	X
Doors in sub-compartment walls	N/A	N/A	✓	X
Doors in compartment walls	N/A	N/A	X	X
Doors to protected shafts	N/A	N/A	X	X

**Notes:**  
 Fire smoke dampers and air transfer grilles activated by the fire alarm provide more responsive containment than thermally activated devices and are considered preferable.  
 Air transfer grilles should not be fitted in fire doors unless accompanied by a test certificate provided by the door manufacturer.

Table 7 Permissible locations of transfer grilles, fire dampers, and fire and smoke dampers

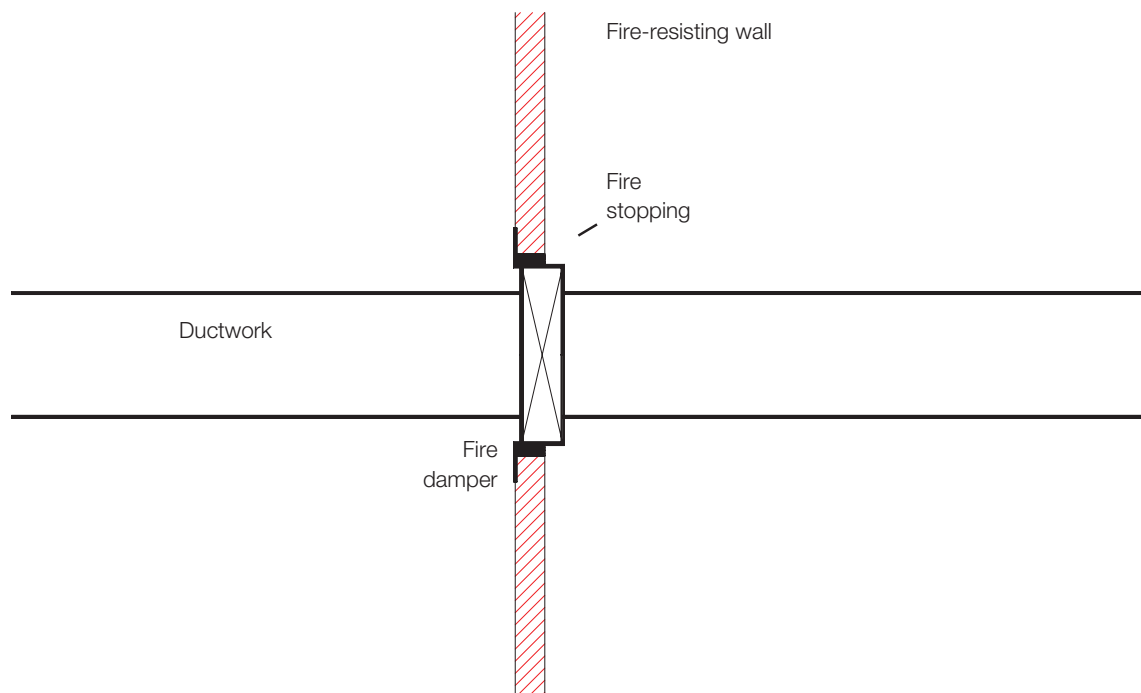

Actuation of dampers:

- i) in accordance with BS5588: Part 9;
- ii) by the operation of the detection and alarm system either side of the compartment or sub-compartment wall; or
- iii) by operation of fusible link in walls to fire hazard rooms

Figure 16 Fire and smoke damper in compartment, sub-compartment wall or wall to fire hazard room

**5.54** Ductwork passing through, or over, hazard rooms should be provided with fire dampers in accordance with Figure 17.

**i. ductwork passing through but not serving fire hazard room**

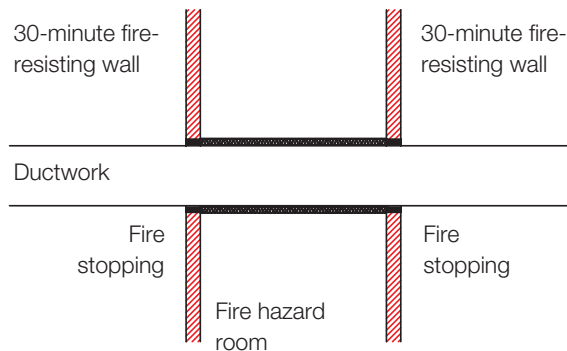

- i. fire dampers not required;
- ii. ductwork in the hazard room to have 30 minutes' fire resistance (integrity and insulation) when tested to the relevant parts of BS 476.

**ii. ductwork passing over fire hazard room fitted with fire-resisting ceiling**

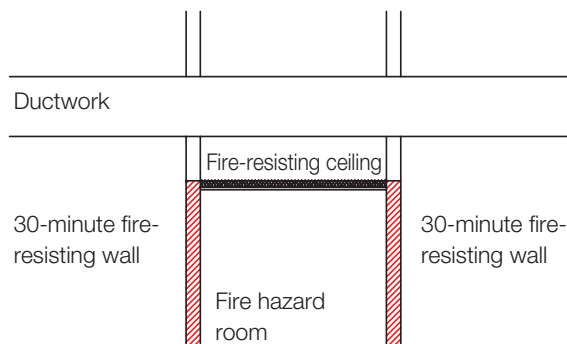

- i. fire dampers not required;
- ii. ceiling to be non-demountable and have a minimum period of fire resistance of 30 minutes, when tested (complete with any lighting units) from below in accordance with BS 476 Parts 20 and 22.

**iii. ductwork serving fire hazard rooms**

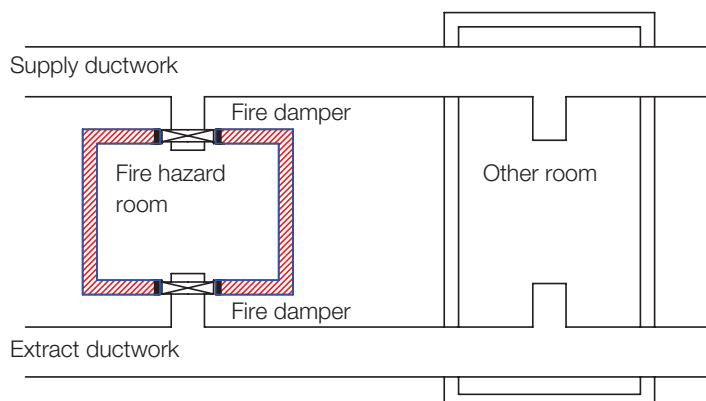

- i. ducts should not pass through the hazard room if the duct serves the fire hazard room and other rooms beyond the fire hazard room;
- ii. the fire hazard room should be served by spurs fitted with fire dampers operated by fusible links;
- iii. where flexible connections are used, they should comply with BS 5588-9 and not pass through the fire-resisting walls

Figure 17 Options for the design of ductwork passing through or serving a fire hazard room

**5.55** Where ventilation systems utilise air transfer grilles, [Table 7](#) indicates the types of air transfer grille permitted in the different forms of construction.

**5.56** The fire resistance may be achieved by the ductwork material itself, or through the application of a protective material.

### Operation of ventilation plant

**5.57** The ventilation plant should not necessarily automatically shut down on the operation of the automatic fire detection and alarm system. For example, in areas where the automatic shutdown of ventilation plant will impede the clean air-flow paths and room-air dilution rates, this may lead to an increased risk of healthcare-associated infections. Where, due to operational reasons, the ventilation plant continues to run, override facilities will be required and the shutdown of the system should be controlled from panels located either at department entrances or adjacent to the main fire alarm indicator panels.

### Cavity barriers

**5.58** Concealed spaces or cavities in the construction of a building may permit the rapid spread of fire and smoke. It is possible for fire and smoke to be transferred to areas remote from the seat of the fire by way of uninterrupted concealed spaces. For this reason, it is essential that fire-resisting barriers are provided to restrict the size of these concealed spaces.

**5.59** In healthcare premises, the subdivision provided through the requirements for hazard protection, sub-compartmentation and compartmentation is such that generally the additional subdivision of ceiling voids for cavity barriers is not required. The exception to this is where sub-compartment walls and walls to fire hazard rooms are terminated at 30-minute fire-resisting ceilings.

**5.60** Irrespective of the above, there is a requirement to prevent the interconnection of horizontal and vertical cavities.

**5.61** Guidance on the construction and fixing of cavity barriers is provided in [Appendix E](#).

**5.62** With the exception of the ceiling void above operating departments (see [paragraph 5.66](#)), 30-minute fire-resisting barriers should be provided to subdivide concealed roof or ceiling voids, so that the maximum dimension of uninterrupted roof or ceiling void should not exceed 20 m. Wherever possible, cavity barriers should be positioned to coincide with fire-resisting walls.

**5.63** Thirty-minute fire-resisting cavity barriers should also be provided:

- a. to prevent the interconnection of vertical and horizontal cavities;
- b. at the intersection of fire-resisting construction and elements containing a concealed space;
- c. within the void behind the external face of rain-screen cladding, at every floor level and on the line of compartment walls abutting the external wall.

**5.64** Cavity barriers should not be provided:

- a. in cavity walls, as illustrated in [Figure 18](#); or
- b. in double-skinned insulated roof sheeting, as illustrated in [Figure 19](#); or
- c. below a floor next to the ground or oversite concrete providing:
  - (i) the cavity is less than 1000 mm in height; or
  - (ii) it is not accessible by persons; and
  - (iii) there are no openings in the floor such that it is possible for combustibles to accumulate in the cavity.

**5.65** Openings in barriers should be limited to those for:

- a. doors which have at least 30 minutes' fire resistance;



**Section through cavity wall**

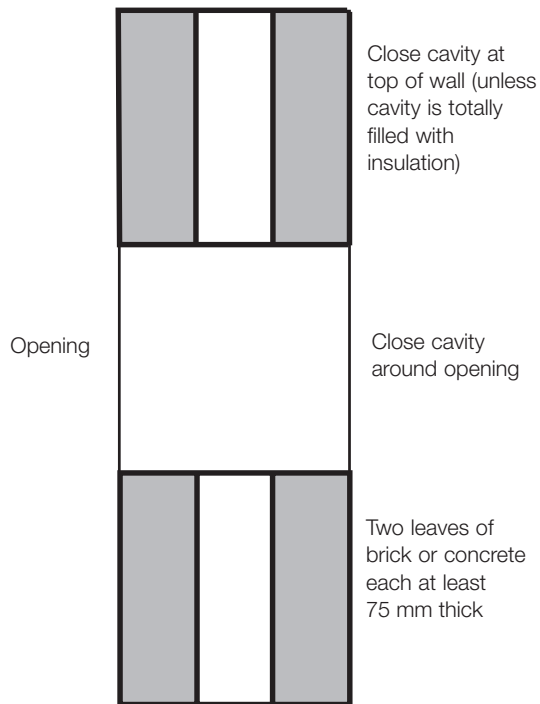

Note:

Combustible materials should not be placed in or exposed to the cavity, except for:

- a. timber lintels, window or door frames, or the ends of timber joists;
- b. pipes, conduit or cable;
- c. DPC, flashing cavity closer or wall tie;
- d. thermal insulating material (two leaves of brick, block or concrete each at least 75 mm thick, 100 mm maximum cavity width)

**Figure 18 Cavity wall not requiring a cavity barrier**

**i. acceptable without cavity barriers**

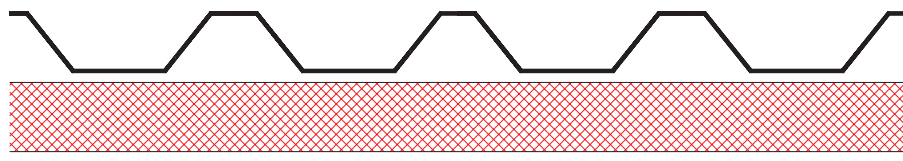

The insulation should make contact with both skins of sheeting

**ii. cavity barriers required**

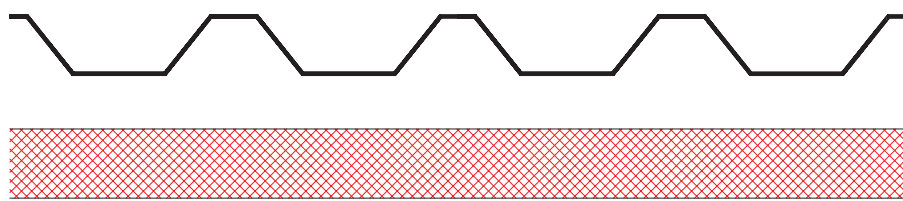

**Figure 19 Cavity barriers in double-skinned insulated roof sheeting**

- b. pipes (see [paragraph 5.32](#));
- c. cables or conduits;
- d. openings fitted with a suitably mounted automatic fire and smoke damper (see [Table 7](#));
- e. ducts which, unless they are fire-resisting, are fitted with a suitably mounted automatic fire damper where they pass through the cavity barrier.

### Cavity barriers above operating departments

**5.66** The complexities of ventilation ductwork systems above operating departments mean that the provision of cavity barriers may seriously compromise service access and means of escape for maintenance staff. Therefore cavity barriers should not be provided over operating departments.

**5.67** Additionally, operating departments have restricted access and are well supervised when in use, and hazard areas are enclosed within fire-resisting construction.

### Sprinklers

**5.68** With the exception of buildings over 30 m in height, the guidance in this document does not require the installation of sprinklers in patient care areas of healthcare buildings. However, the design team is expected to consider the advantages that might be gained by installing life-safety sprinklers throughout the building or to specific areas. Where specific hazards are identified in the building, it may be more appropriate to consider the application of an alternative fire suppression system, such as high pressure water mist technologies.

**5.69** Life-safety sprinklers will:

- a. limit the size of a fire;
- b. control fire spread;
- c. provide additional time to evacuate;
- d. limit fire damage; and

- e. be beneficial in terms of business continuity.

**5.70** The control of a fire at an early stage extends the time available to evacuate and enhances the protection provided to adjoining places of temporary safety.

**5.71** An extended evacuation time will help where staff numbers are limited or where the attendance of additional responding staff may be delayed.

**5.72** The control of a fire can reduce the need for onward phases of evacuation. This will benefit very high dependency patients and help maintain continuity of care.

**5.73** For premises providing care only for independent patients, the inclusion of sprinklers may support the use of smoke-retarding construction as an alternative to 30 minutes' fire-resisting construction. Any solution adopting this approach should be fully supported by fire engineering evidence to demonstrate that an equivalent level of safety will be maintained as with a standard HTM-compliant design solution.

**5.74** To avoid conflict, the AFD zoning arrangements should take precedence over the sprinkler system, including in the cause and effect.

**5.75** Life-safety systems are defined in BS EN 12845 as “sprinkler systems forming an integral part of measures required for the protection of life”.

**5.76** The performance of life-safety sprinklers can be enhanced by the specification and installation of quick-response sprinkler heads that enable the activation of the system quickly after the heads have reached their operating temperature. This response is quicker than conventional heads that have been developed for property protection.

**5.77** Where a sprinkler system is specifically recommended within this document, it should

be provided in the building or separated part and designed and installed in accordance with either:

- a. the requirements of BS 5306-2, including the relevant hazard classification together with the additional requirements for life safety; or
- b. the requirements of BS EN 12845, including the relevant hazard classification together with the special requirements for life safety systems.

### Note

Any sprinkler system installed to satisfy the requirements of this Health Technical Memorandum or Part B of the Building Regulations should be regarded as a life-safety system. However, there may be some circumstances where a particular life-safety requirement specified in BS 5306-2 or BS EN 12845 is inappropriate or unnecessary.

**5.78** Water supplies for non-residential sprinkler systems should consist of either:

- a. systems designed and installed to BS 5306-2; or
- b. systems designed and installed to BS EN 12845.

**5.79** These systems consist of either:

- a. two single water supplies complying with BS 5306-2, clause 13.1.2, where each is independent of the other; or
- b. two stored water supplies, where:
  - (i) gravity or suction tanks should be either Type A, Type D or their equivalent (see BS 5306-2, clause 17.4.11.6); and
  - (ii) any pump arrangements should comply with BS 5306-2, clause 17.4.1.5; and
  - (iii) the capacity of each tank should be equivalent to at least half the

specified minimum water volume of a single full capacity tank, as appropriate to the hazard; or

- (iv) one tank should be equivalent to half the specified water volume of a single full capacity tank and the other should not be less than half the minimum volume of a reduced capacity tank (see BS 5306-2, Table 25), as appropriate to the hazard.

### Note

The requirement for inflow should be met. Whichever water storage arrangement is used at (iii) or (iv) above, the total design capacity of the water supply, including any inflow for a reduced capacity tank, should be at least equivalent to a single full capacity tank complying with Tables 21–24 of BS 5306-2, as appropriate to the hazard and pipework design.

## Systems designed and installed to BS EN 12845

**5.80** These systems consist of either:

- a. two single water supplies complying with BS EN 12845, clause 9.6.1, where each is independent of the other; or
- b. two stored water supplies, where:
  - (i) gravity or suction tanks should satisfy the all requirements of BS EN 12845, clause 9.6.2 b) other than capacity; and
  - (ii) any pump arrangements should comply with BS EN 12845, clause 10.2; and
  - (iii) the capacity of each tank is equivalent to half the specified minimum water volume of a single full capacity tank, as appropriate to the hazard; or

- (iv) one tank should be at least equivalent to half the specified water volume of a single full capacity tank and the other should not be less than the minimum volume of a reduced capacity tank (see BS EN 12845, clause 9.3.40), as appropriate to the hazard.

### Note

The requirements for inflow should be met. Whichever water storage arrangement is used at (iii) or (iv) above, the total capacity of the water supply, including any inflow for a reduced capacity tank, should be at least equivalent to a single full capacity tank complying with BS EN 12845, Tables 9 and 10 or clause 9.3.2.3, as appropriate to the hazard and pipework design.

**5.81** Where pumps are used to draw water from two tanks, each pump should be arranged to draw water from either tank and so that any one pump or either tank could be isolated.

**5.82** The sprinkler water supplies should generally not be used as connections for other services or other fixed fire-fighting systems.

**5.83** In patient-access areas of healthcare premises, the sprinkler system should be a life-safety system, fitted with quick-response heads as defined in the Fire Protection Association's 'LPC rules for automatic sprinkler installations'.

**5.84** Areas of the building not provided with sprinkler protection should be separated from those areas that are protected, by the provision of 60-minute fire-resisting structure (integrity and insulation).

### Effect on other fire precautions

**5.85** In those parts of healthcare buildings where sprinkler systems are provided, the effect of sprinklers on the overall package of fire precautions has to be considered to ensure that a cost-effective fire safety strategy is provided. Where sprinklers are installed in healthcare premises in accordance with the above guidance, some of the requirements of this document may be modified to take account of the effect of sprinkler operation at an early stage of fire development.

**5.86** Where sprinklers are installed, the guidance may be modified subject to a suitable and sufficient risk assessment being undertaken and the information being recorded in the fire safety manual. Examples include:

- a. progressive horizontal evacuation (paragraphs 3.6–3.15);
- b. glazing in sub-compartment walls (paragraphs 5.23–5.25);
- c. elements of structure (paragraphs 5.1–5.7 and 5.14–5.15);
- d. compartmentation (paragraphs 5.8–5.13);
- e. fire hazard rooms and areas (paragraphs 5.40–5.44);
- f. external fire spread (paragraphs 6.5–6.15);
- g. number and location of fire-fighting shafts (paragraphs 7.11 and 7.13).

## 6. External fire spread

### Requirement

Chapter 6 provides guidance to comply with the following Requirement from Part B of Schedule 1 of the Building Regulations 2010.

### Requirement

External fire spread

B4

- (1) The external walls of the building shall adequately resist the spread of fire over the walls and from one building to another, having regard to the height, use and position of the building.
- (2) The roof of the building shall adequately resist the spread of fire over the roof and from one building to another, having regard to the use and position of the building.

**6.1** In certain circumstances it may be necessary for the external walls or roofs of a healthcare building to provide a period of fire resistance to prevent fire spreading to adjacent buildings or parts of the same building in different compartments.

**6.2** For walls, this requirement is determined by a combination of space separation between buildings and the amount of unprotected area within the walls.

**6.3** Generally, roofs are the topmost element of the building and as a consequence are not required to provide a period of fire resistance from below. However, where a low-level roof abuts an external wall of a patient-access area,

a portion of the roof should provide some fire resistance to prevent the fire spreading through the roof to other parts of the same building in different compartments (see also paragraphs 6.12 and 6.13).

**6.4** With the exception of unprotected areas, the minimum period of fire resistance provided by external walls should be as in Table 8.

Height to the top floor	Minimum period of fire resistance
Not more than 5 m	30 minutes
Over 5 m	60 minutes

**Notes:**

1. The minimum period of fire resistance relates to integrity and load-bearing capacity. The minimum provision for insulation is 15 minutes unless the external wall is less than 1000 mm from a boundary or adjacent building, when the requirement for insulation should be the same as that for integrity and load-bearing capacity.
2. An external wall that is also an element of structure should comply with Table 5.

Table 8 Minimum period of fire resistance of external walls

### Space separation

**6.5** In healthcare buildings up to 12 m in height, the maximum percentage of unprotected area in an external wall, in relation to the distance to adjacent compartments, buildings or boundaries, should be determined from the graph in Figure 20 (Figure 21 provides guidance on how to establish the relevant boundary, and Figure 22 provides guidance on establishing the notional boundary).

**6.6** In healthcare buildings over 12 m in height, the maximum percentage of unprotected area in an external wall, in relation to the distance to adjacent compartments, buildings or boundaries, should be determined from the

Distance between face of building and relevant boundary (m)

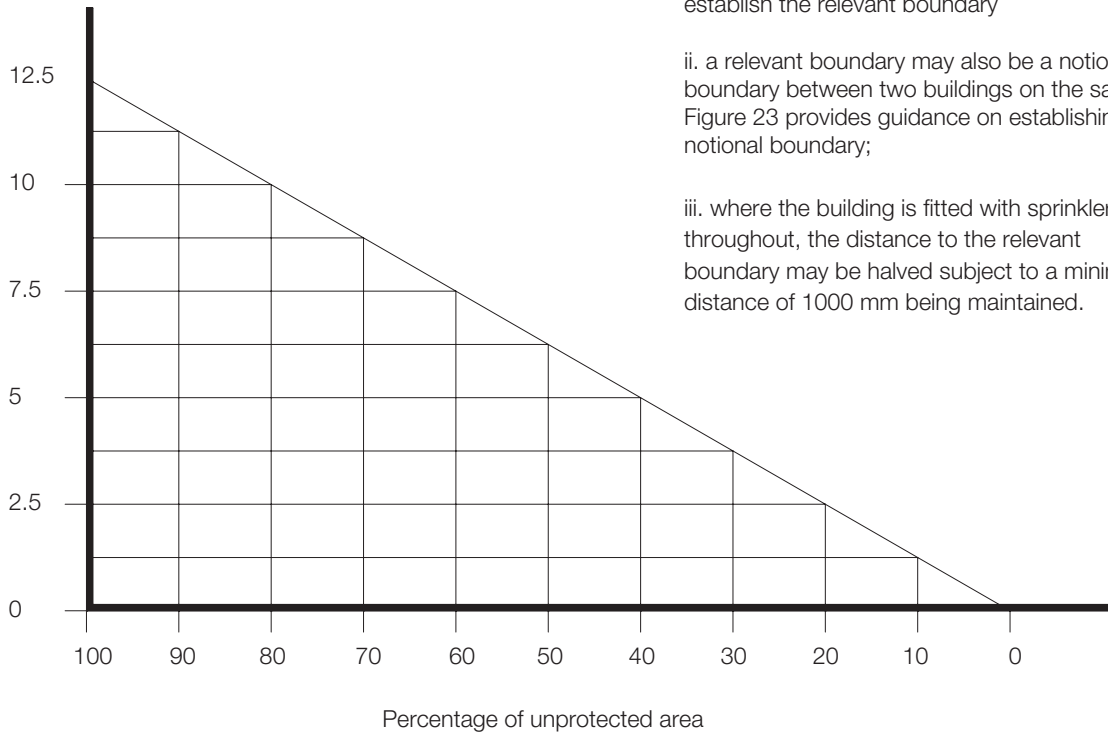

Notes:

- i. Figure 22 provides guidance on how to establish the relevant boundary
- ii. a relevant boundary may also be a notional boundary between two buildings on the same site; Figure 23 provides guidance on establishing the notional boundary;
- iii. where the building is fitted with sprinklers throughout, the distance to the relevant boundary may be halved subject to a minimum distance of 1000 mm being maintained.

Figure 20 Permitted unprotected area – method of determining the amount of unprotected area in an external wall

**For a boundary to be relevant it should:**

- a. coincide with; or
- b. be parallel to; or
- c. be at an angle of not more than 80° to

the side of the building.

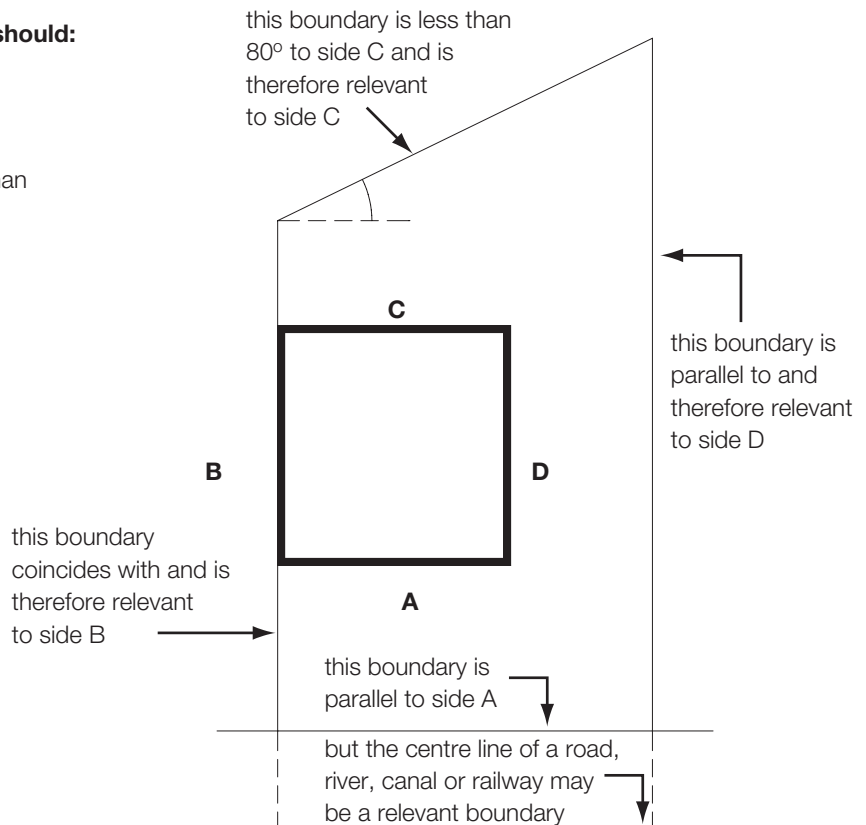
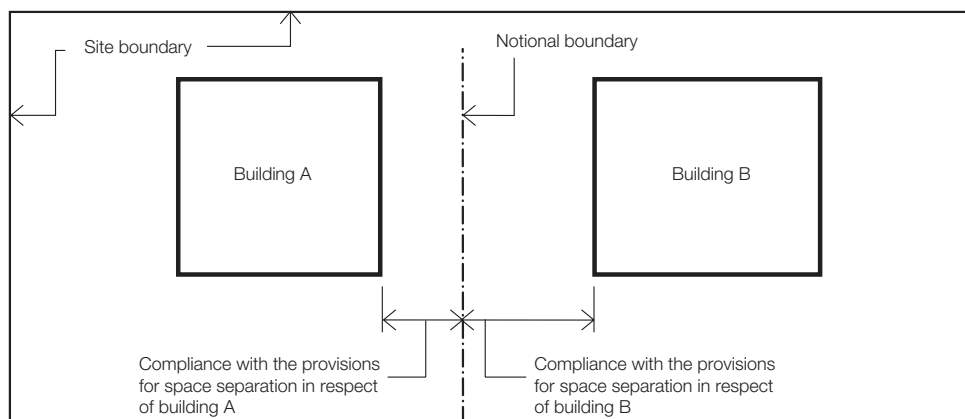

Figure 21 Relevant boundary area



The notional boundary should be set in the area between the two buildings using the following rules:

1. The notional boundary is assumed to exist in the space between the buildings and is positioned so that one of the buildings would comply with the provisions for space separation having regard to the amount of its unprotected area. In practice, if one of the buildings is existing, the position of the boundary will be set by the space-separation factors for that building.
2. The siting of the new building, or the second building if both are new, can then be checked to see that it also complies, using the notional boundary as the relevant boundary for the second building.

For further information about notional boundaries, see paragraph 13.6 in Approved Document B.

Figure 22 Notional boundary

methods set out in the BRE Report 187 – ‘External fire spread: building separation and boundary distances’.

**6.7** When calculating the amount of unprotected area:

- a. small unprotected areas as indicated in Figure 23 may be disregarded;
- b. an external surface of combustible material more than 1 mm thick should be counted as an unprotected area amounting to half the actual area of the combustible material.

### Canopies

**6.8** Provided a canopy is more than 1 m from a relevant boundary, the provision for space separation may be disregarded.

### Surfaces of external walls

**6.9** The surfaces of external walls of healthcare premises should provide a surface spread of flame classification of Class 0 (European Class: B-s3,d2).

### Note

The national classifications do not automatically equate with the equivalent European classifications; therefore, products cannot typically assume a European class unless they have been tested accordingly.

**6.10** When a classification includes “s3,d2”, this means that there is no limit set for smoke production and/or flaming droplets/particles.

### Surfaces of roofs

**6.11** All healthcare buildings providing in-patient facilities or invasive procedures should have roof coverings complying with the Approved Document B.

### Junction of walls and low-level roofs

**6.12** Where a roof abuts an external wall, the roof should provide a minimum period of fire resistance of 60 minutes (integrity and insulation) for a distance of 3 m from the wall (see Figure 24).

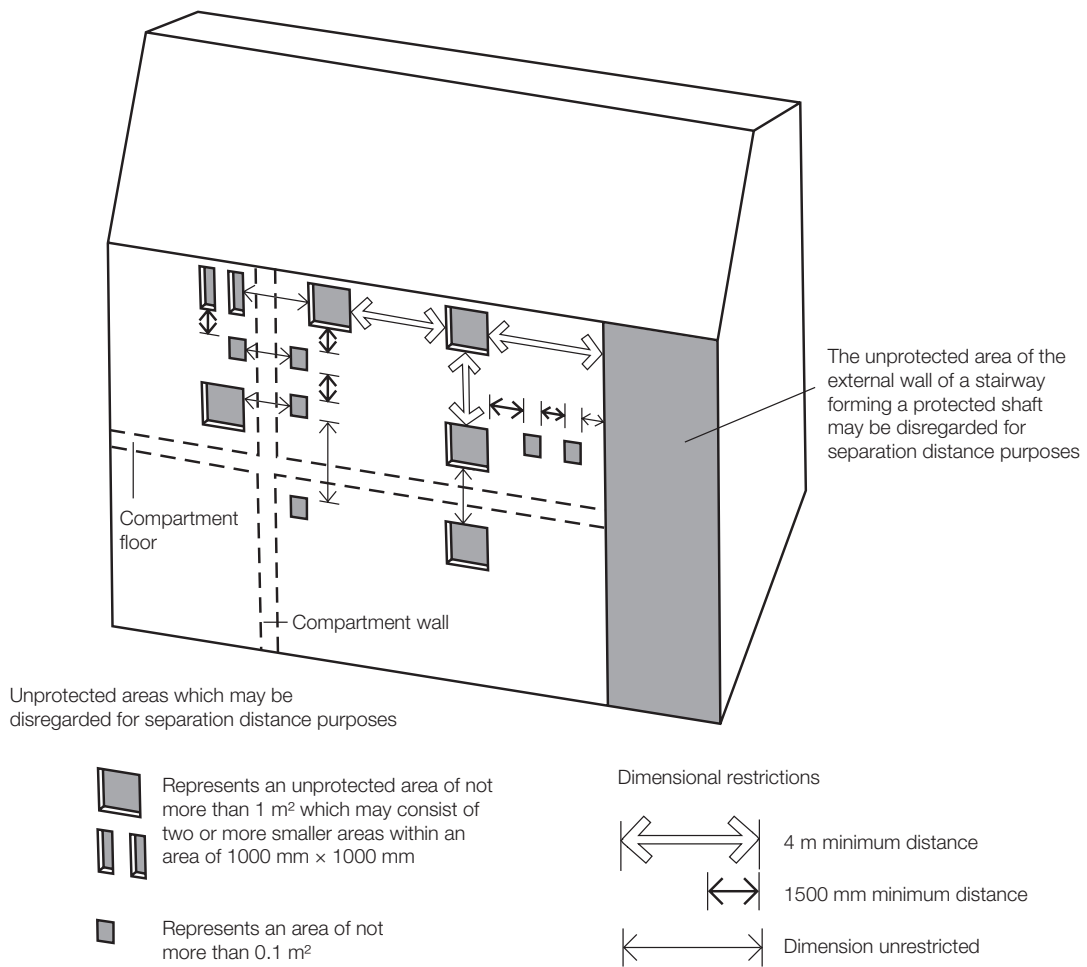

Figure 23 Unprotected areas which may be disregarded

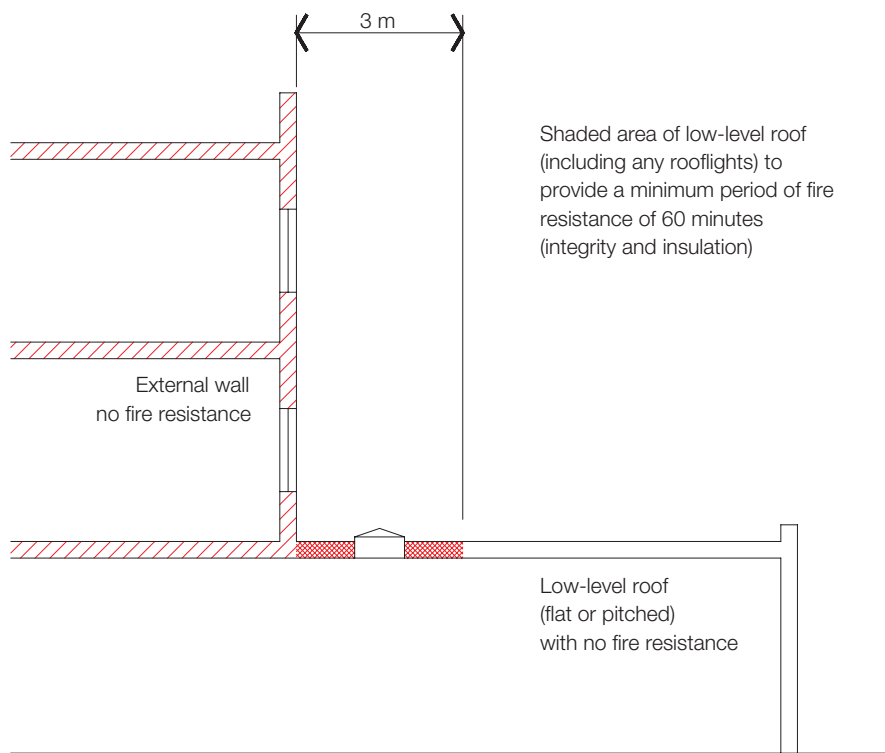

Figure 24 Fire-resistance at junction of external walls and low-level roof



**6.13** Where sprinklers are installed throughout the area below the low-level roof, paragraph 6.12 above does not apply.

## Junction of compartment and sub-compartment walls and external walls

**6.14** Where:

- a. a compartment wall (or sub-compartment wall) meets an external wall; or
- b. a protected shaft meets an external wall,

a 1 m wide storey-height strip of external wall that has a similar period of fire resistance should be provided to prevent lateral fire spread (see Figure 25).

**6.15** Where sprinklers are installed on both sides of the compartment (or sub-compartment wall), paragraph 6.14 does not apply.

## Additional requirements for car parks

**6.16** Buildings or parts of buildings used as parking for cars and other light vehicles are unlike other buildings in certain respects which

merit some departure from the usual measures to restrict the fire spread within buildings, specifically:

- the fire load is well defined; and
- where the car park is well ventilated, there is a low probability of fire spread from one storey to another. Ventilation is the important factor and, as heat and smoke cannot be dissipated so readily from a car park that is not open-sided, fewer concessions are made. The guidance in paragraphs 6.19 to 6.24 below is concerned with three ventilation methods – open-sided (high level of natural ventilation), natural ventilation and mechanical ventilation.

**6.17** Notwithstanding the recommendations of Table 1, where it is proposed to include car parking under any part of the healthcare premises, the following additional requirements should be provided.

### All car parks

**6.18** Access from the car park to a healthcare building should be through a protected lobby. In addition, vertical access from the car park to the building should be via a stairway or stairways, provided with protected lobbies,

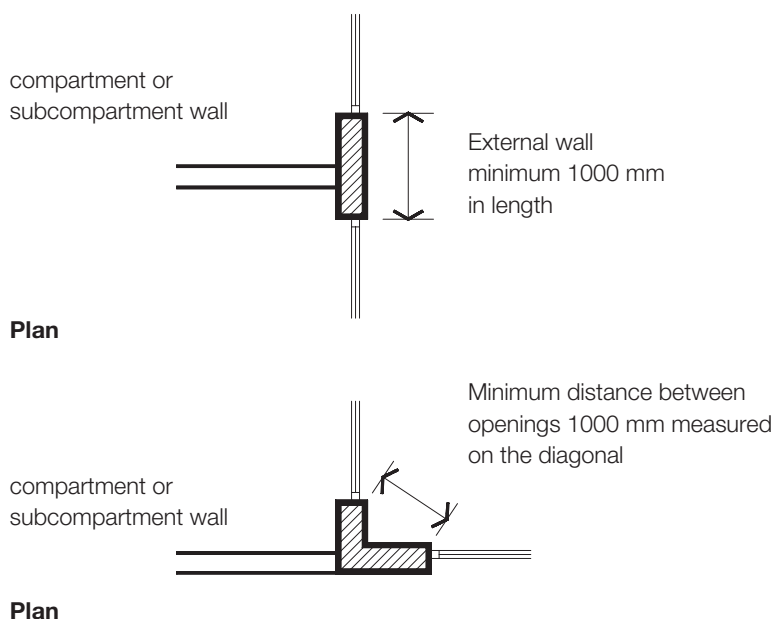

Figure 25 Junction of compartment or sub-compartment wall and external wall

serving the car-park storeys and providing access to one storey only of the building.

### Open-sided car parks

**6.19** If the building, or separated part containing the car park, complies with the following provisions, it may be regarded as an open-sided car park for the purposes of fire resistance assessment in Table A2 of Approved Document B – ‘Fire safety’. The provisions are that:

- a. there should not be any basement storeys;
- b. each storey should be naturally ventilated by permanent openings at each car parking level, having an aggregate vent area not less than 1/20th of the floor area at that level, of which at least half (1/40th) should be equally provided between two opposing walls (where one element of structure supports or carries or gives stability to another, the fire resistance of the supporting element should be no less than the minimum period of fire resistance for the other element, whether that other element is load-bearing or not);
- c. if the building is also used for any other purpose, the part forming the car park is a separated part and the fire resistance of any element of structure that supports or carries or gives stability to another element in the other part of the building should be no less than the minimum period of fire resistance for the elements it supports;
- d. all materials used in the construction of the building, compartment or separated part should be non-combustible, except for:
  - (i) any surface finish applied to a floor or roof of the car park, or within any adjoining building, compartment or separated part of the structure enclosing the car

park, if the finish meets all relevant aspects of the guidance requirements of [Chapters 4 and 5](#) of this guidance.

- (ii) any fire door;
- (iii) any attendant’s kiosk not exceeding 15 m<sup>2</sup> in area; and
- (iv) any shop mobility facility.

### Car parks that are not open-sided

**6.20** Where car parks do not have the standard of ventilation set out in paragraph 6.19, they are not regarded as open-sided and a different standard of fire resistance is necessary (the relevant provisions are given in Table A2 of Approved Document B). Such car parks still require some ventilation, which may be by natural or mechanical means, as described in paragraphs 6.21 or 6.22. The provisions of paragraph 6.19 apply to all car-park buildings, whatever standard of ventilation is provided.

### Natural ventilation to car parks

**6.21** Where car parks that are not open-sided are provided with some, more limited, natural ventilation, each storey should be ventilated by permanent openings (which can be at ceiling level) at each car-parking level. These should have an aggregate free-vent area of not less than 1/40th of the floor area at that level, of which at least half should be split equally (1/160th on each side) and provided between two opposing walls (see Approved Document F – ‘Ventilation’ for additional guidance on normal ventilation of car parks).

### Mechanical ventilation to car parks

**6.22** In most basement car parks, and in enclosed car parks, it may not be possible to obtain the minimum standard of natural ventilation openings set out in paragraph 6.21. In such cases a system of mechanical ventilation should be provided as follows:

- a. the system should be independent of any other ventilating system (other than

any system providing normal ventilation to the car park) and be designed to operate at 10 air changes per hour in a fire condition (see Approved Document F – 'Ventilation' for guidance on normal ventilation of car parks);

- b. the system should be designed to run in two parts, each part capable of extracting 50% of the rates set out in (a) above, and designed so that each part may operate singly or simultaneously;
- c. each part of the system should have an independent power supply that would operate in the event of failure of the main supply;
- d. extract points should be arranged so that 50% of the outlets are at high level and 50% at low level;

- e. the fans should be rated to run at 300°C for a minimum of 60 minutes, and the ductwork and fixings should be constructed of materials having a melting point not less than 800°C.

**6.23** For further information on equipment for removing hot smoke, refer to BS EN 12101-3: 2002.

**6.24** An alternative method of providing smoke ventilation from enclosed car parks is given in the BRE Report 368: 'Design methodologies for smoke and heat exhaust ventilation' and BS 7376-7:2006.

## 7. Access and facilities for the fire-and-rescue service

### Requirement

Chapter 7 provides guidance to comply with the following Requirement from Part B of Schedule 1 of the Building Regulations 2010.

### Requirement

Access and facilities for the fire service

B5

- (1) The building shall be designed and constructed so as to provide reasonable facilities to assist firefighters in the protection of life.
- (2) Reasonable provision shall be made within the site of the building to enable fire appliances to gain access to the buildings.

**7.1** The fire-and-rescue service, once alerted, will attend quickly and, once there, should be provided with adequate facilities to ensure the protection of life and property. Particular matters which require consideration are:

- a. site access;
- b. vehicular access around the buildings for fire appliances;
- c. access into the building for the fire-fighting personnel;

- d. the provision of fire mains within the building;
- e. private fire hydrants;
- f. venting for heat and smoke from basement areas.

### Site access

**7.2** When considering site access for the fire-and-rescue service, the following should be considered:

- a. the location and number of site access points;
- b. the design of the internal roadways with respect to width, radii of bends, gradients, clearance between and under buildings;
- c. the weight and turning circle of the fire appliances.

**7.3** A minimum of two access points to the site, suitable for use by the fire-and-rescue service, should be provided for fire appliances. Their location should be agreed with all relevant authorities.

**7.4** New hospital roads that may be used by fire appliances should comply with [Table 10](#) of this Health Technical Memorandum. One access point for the fire-and-rescue service may be an emergency access point dedicated solely for the use of the fire service.

## Access around the building

**7.5** Access around a healthcare building is required to enable high-reach appliances to be used where necessary, and to enable pumping appliances to supply water and equipment for fire-fighting and rescue activities.

**7.6** Where access is provided to an elevation in accordance with [Table 9](#), overhead obstructions should be avoided in the zone indicated in Figure 26.

**7.7** Turning facilities should be provided in any dead-end route that is more than 20 m long.

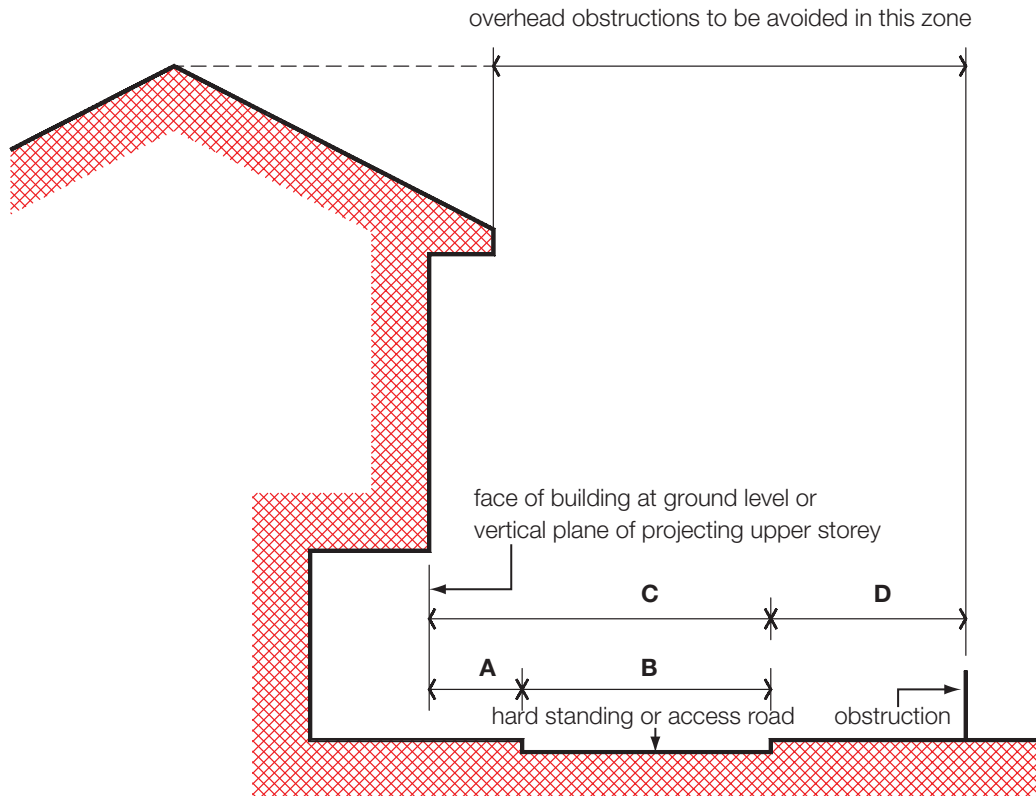

	Type of appliance	
	Turntable ladder Dimension (m)	Hydraulic platform Dimension (m)
A. Maximum distance of near edge of hard standing from building	4.9	2.0
B. Minimum width of hard standing	5.0	5.5
C. Minimum distance of further edge of hard standing from building	10.0	7.5
D. Minimum width of unobstructed space (for swing of appliance platform)	N/A	2.2

**Note:**

1. Hard standing for high-reach appliances should be as level as possible and should not exceed a gradient of 1 in 12.

2. Fire appliances are not standardised. Some fire services have appliances with a greater weight or different size. In consultation with the fire-and-rescue authority, the building control body should adopt the relevant dimensions and ground-loading capacity.

**Figure 26** Relationship between building and access roads or hard standings for high-reach appliances

This can be by hammerhead or turning circle, designed on the basis of Table 10 and Figure 27.

**7.8** Access for fire appliances to healthcare buildings not fitted with internal fire mains should comply with the guidance in Table 9.

Total floor area (m <sup>2</sup> )	Height above ground of top storey (m)	Provide vehicle access to:	Type of appliance
Up to 2000	Up to 9	Within 45 m	Pump
	Over 9	15% of perimeter	High-reach
2000 to 8000	Up to 9	15% of perimeter	Pump
	Over 9	50% of perimeter	High-reach
8000 to 16,000	Up to 9	50% of perimeter	Pump
	Over 9	50% of perimeter	High-reach
16,000 to 24,000	Up to 9	75% of perimeter	Pump
	Over 9	75% of perimeter	High-reach
Over 24,000	Up to 9	100% of perimeter	Pump
	Over 9	100% of perimeter	High-reach

**Note:** The total floor area is the aggregate of all floors within the building.

Table 9 Fire-and-rescue-service access around hospitals not fitted with fire mains

Appliance type	Minimum width of road between kerbs (m)	Minimum width of gateways (m)	Minimum turning circle between kerbs (m)	Minimum turning circle between walls (m)	Minimum clearance height (m)	Minimum carrying capacity (tonnes)
Pump	3.7	3.1	16.8	19.2	3.7	12.5
High-reach	3.7	3.1	26.0	29.0	4.0	17.0

**Notes**

1. Fire appliances are not standardised. Some fire services have appliances of greater weight or different size. In consultation with the fire-and-rescue authority, the building control body may adopt other dimensions in such circumstances.
2. Because the weight of high-reach appliances is distributed over a number of axles, it is considered that their infrequent use of a carriageway or route designed to 12.5 tonnes should not cause damage. It would therefore be reasonable to design the road base to 12.5 tonnes, although structures such as bridges should have the full 17-tonne capacity.

Table 10 Typical vehicle access route specification

Fire and rescue service vehicles should not have to reverse more than 20 m from the end of an access road

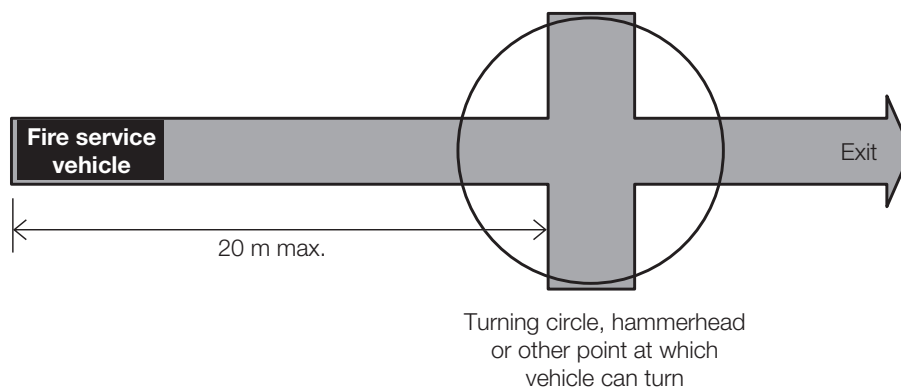

Figure 27 Turning circles

## Access and facilities for the fire service

**7.9** In low-rise buildings without deep basements, the needs of the fire service will be met by a combination of the normal means of escape and the measures required for vehicular access around the building.

**7.10** The requirements for additional facilities (fire-fighting shafts, fire mains and fire hydrants) for the fire-and-rescue service are determined by:

- a. the height of the building;

- b. the depth of basements;
- c. floor area; and
- d. the provision of hospital streets.

### Number and location of fire-fighting shafts – health buildings not provided with a hospital street

**7.11** For health buildings not provided with hospital streets, fire-fighting shafts should be provided in accordance with the requirements of Table 11.

	Area of largest floor							
	No sprinklers				Sprinklers			
	Less than 900 m <sup>2</sup>	Between 900 m <sup>2</sup> and 1800 m <sup>2</sup>	Between 1800 m <sup>2</sup> and 3300 m <sup>2</sup>	Over 3300 m <sup>2</sup>	Less than 900 m <sup>2</sup>	Between 900 m <sup>2</sup> and 1800 m <sup>2</sup>	Between 1800 m <sup>2</sup> and 3300 m <sup>2</sup>	Over 3300 m <sup>2</sup>
Below ground								
Two basement storeys	Not required	1	2	3 plus 1 for every additional 1500 m <sup>2</sup>	Not required	1	2	3 plus 1 for every additional 1500 m <sup>2</sup>
More than 10 m (see note 2)	1 + lift	1 + lift	2 + lift	3 + lift plus 1 for every additional 1500 m <sup>2</sup>	1 + lift	1 + lift	2 + lift	3 + lift plus 1 for every additional 1500 m <sup>2</sup>
Above ground								
Up to 12 m	Not required	Not required	Not required	Not required	Not required	Not required	Not required	Not required
Between 12 m and 18 m	1	1	2	3 plus 1 for every additional 900 m <sup>2</sup>	Not required	Not required	Not required	Not required
Over 18 m (see note 2)	1 + lift	2 + lift	2 + lift	3 + lift plus 1 for every additional 900 m <sup>2</sup>	1 + lift	2 + lift	2 + lift	3 + lift plus 1 for every additional 1500 m <sup>2</sup>
Hose laying distance (see note 3)	45 m along a route suitable for laying hose				60 m along a route suitable for laying hose			
<b>Notes:</b>								
1. Depth of basements and heights of storey above ground are all measured from fire service vehicle access level.								
2. One fire-fighting shaft should also include a fire-fighting lift.								
3. Fire-fighting shafts, irrespective of building height, should be located to meet the maximum hose laying distances. In order to meet the hose laying criterion it may be necessary to provide additional fire mains in escape stairways. This does not imply that these stairs should be otherwise designed as fire-fighting shafts.								
4. For further guidance on measuring the height of a building, reference should be made to Appendix C of Approved Document B ('Fire safety'). To count the number of storeys in a building, count only at the position which gives the greatest number.								

Table 11 The number of fire-fighting shafts

**7.12** If a fire-fighting shaft is required to serve a basement it need not also serve the upper floors unless they also qualify because of the height or size of building. Similarly, a shaft serving upper storeys need not serve a basement that is not large or deep enough to qualify in its own right; however, a fire-fighting stair and any fire-fighting lift should service all intermediate storeys between the highest and lowest storeys that they serve.

**7.13** Fire-fighting shafts should serve all floors through which they pass.

## Design and construction of fire-fighting shafts

**7.14** Fire-fighting stairways and lifts should be approached from inside the building through a fire-fighting lobby.

**7.15** Fire-fighting shafts should be equipped with fire mains having outlet connections and valves in every fire-fighting lobby except at access level.

**7.16** Where fire-fighting shafts include fire-fighting lifts, a fire-fighting lift installation includes:

- a. the lift car itself;
- b. the lift well; and
- c. the lift machinery space together with the lift control system and the lift communications system.

**7.17** The shaft should be constructed generally in accordance with clauses 7 and 8 of BS 5588-5. Fire-fighting lift installations should conform to BS EN 81-72 and to BS EN 81-1 or BS EN 81-2 as appropriate for the particular type of lift.

### Health buildings provided with a hospital street

**7.18** Fire-fighting shafts are not required in health buildings provided with hospital streets. In these buildings a minimum of two stairways

should be provided within 15 m of a final exit, which itself is within 18 m of a suitable fire service access point.

**7.19** All hospital streets should have fire main outlets located at department entrances so that every part of every storey is no more than 45 m from a fire outlet connection, measured along a route that is suitable for laying hose. Fire hoses may wedge open cross-corridor fire doors designed to prevent the passage of smoke along the corridor; to prevent this it is recommended that sections of the hospital street that provide access to a department should be provided with a fire main outlet within that section of a hospital street.

**7.20** Where healthcare buildings with a hospital street have upper storeys over 18 m above fire service vehicle access level, or a basement at more than 10 m below ground or fire service vehicle access level, lifts for use by the fire-and-rescue service are required; these should be:

- a. located within the hospital street immediately adjacent to a stairway;
- b. accessed directly off the hospital street;
- c. within 18 m of an entrance suitable for use by the fire-and-rescue service.

### Note

The fire-and-rescue service should be consulted on any additional requirements they may have for the lift to be suitable for their use.

## Fire mains

**7.21** A fire main should be located in every fire-fighting shaft (see [Table 11](#)) or as required by paragraphs 7.18–7.20.

**7.22** In healthcare premises with a floor over 50 m above ground or access level, wet rising mains should be provided. Where fire mains are



provided in healthcare premises that are lower than this, either wet or dry mains are suitable.

**7.23** Wet or dry fire mains should be designed and installed in accordance with BS 9990:2006.

### Provision of fire hydrants

**7.24** Where a building that has any compartment of 280 m<sup>2</sup> or more is being erected more than 100 m from an existing fire hydrant, additional hydrants should be provided:

- a. buildings provided with fire mains – hydrants should be provided within 90 m of dry fire main inlets;
- b. buildings not provided with fire mains – hydrants should be provided within 90 m of an entry point of the building and not more than 90 m apart.

**7.25** Each fire hydrant should be clearly indicated by a plate, affixed nearby in a conspicuous position, in accordance with BS 3251.

**7.26** Where no piped water supply is available or there is insufficient pressure and flow in the water main, or an alternative arrangement is proposed, the alternative source of supply should be provided in accordance with the following recommendations:

- a. a charged static water tank of at least 45,000 L capacity; or
- b. a spring, river, canal or pond capable of providing or storing at least 45,000 L of water at all times of the year, to which access, space and a hard standing are available for a pumping appliance; or
- c. any other means of providing a water supply for fire-fighting operations considered appropriate by the fire-and-rescue authority.

### Note

The above guidance ensures that adequate water supplies are provided for those buildings which are not constructed within easy access of public hydrants.

### Venting of basements

**7.27** In addition to the measures above, there may be a need in case of fire to remove heat and smoke from basements. In a fire involving a basement, the products of combustion tend to escape via stairways, making access difficult for the fire-and-rescue service. Venting can reduce this problem, improve visibility and lower temperatures, making access for the fire service less difficult.

**7.28** Smoke outlets provide a route for heat and smoke to escape to the open air from the basement level(s). They can also be used by the fire service to let cooler air into the basement.

**7.29** Smoke outlets connected directly to the open air should be provided from every basement storey, except for any basement storey that:

- a. has a floor area of less than 200 m<sup>2</sup>;
- b. is not more than 3 m below the adjacent ground level.

**7.30** Smoke outlets should:

- a. be positioned at high level in the space they serve;
- b. be evenly distributed around the perimeter of the building;
- c. discharge into the open air outside the building.

**7.31** In each basement compartment/sub-compartment, the combined cross-sectional area of all smoke outlets should be not less than 2.5% of the compartment/sub-compartment floor area.

**7.32** If the outlet terminates at a point that is not readily accessible, it should be kept unobstructed and covered with a metal grille or louver.

**7.33** If the outlet terminates at a point which is readily accessible, it may be covered by a suitably indicated panel or pavement light which can be broken out or opened.

**7.34** Outlets should not prejudice the use of escape routes.

### Mechanical smoke extract

**7.35** As an alternative to natural venting, providing the basement is fitted with a sprinkler system to BS EN 12845, a mechanical extract system may be provided.

**7.36** The air extraction system should provide at least 10 air changes per hour and be

capable of handling gas temperatures of up to 300°C for not less than one hour. It should come into operation automatically on the activation of:

- a. the sprinkler system; and/or
- b. the fire detection and alarm system.

### Construction of outlet ducts and shafts

**7.37** Outlet ducts and shafts, including any bulkheads over them, should be enclosed in non-combustible fire-resisting construction.

**7.38** Where there are natural smoke outlet shafts from different basement compartments of the same basement storey, or from different basement storeys, they should be separated from each other by non-combustible fire-resisting construction.

# Appendix A: Glossary of terms

For the purposes of this document the following terms are defined:

**Air transfer grille (fire and cold smoke):**

a device that will allow the passage of air in normal use, but when activated will contain both cold smoke and hot gases – usually activated by heat and an electrical interface with the detection and alarm system.

Assisted patient evacuation: the assisted evacuation of patients by staff, which may include the use of support equipment (for example ski sheets, evacuation chairs, mattresses).

Atrium (plural **atria**): a space, or system of conjoined spaces, within the building that adjoins more than one storey.

## Note

Shafts used solely for stairs, escalators, lifts or services are not classified as atria.

**Auto-suppression:** mechanical methods of fire suppression that are activated automatically – such systems may include water sprinklers and CO<sub>2</sub> flooding systems.

Basement storey: a storey with a floor which at some point is more than 1200 mm below the highest level of ground adjacent to the outside wall.

**Cavity barrier:** a construction, other than a smoke curtain, provided to close a concealed space against penetration of smoke or flame, or provided to restrict the movement of smoke or flame within such a space.

**Circulation space:** a space (including a protected stairway) mainly used as a means of access between a room and an exit from the building or compartment.

**Class 0 surface spread of flame:** the classification achieved by a material or composite product which is either:

- a. composed throughout of materials of limited combustibility; or
- b. a Class 1 material (when tested in accordance with BS 476-7:1971 or 1987) which, when tested in accordance with BS 476-6:1981 or 1989, has a fire propagation index (I) of not more than 12 and a sub-index (i1) of not more than 6.

Class 0 is not a classification identified in any British Standard test.

**Compartment (fire):** a building or part of a building, comprising one or more rooms, spaces or storeys, constructed to prevent the spread of fire to or from another part of the same building, or an adjoining building. (A roof space above the top storey of a compartment is included in that compartment.)

**Compartment floor:** a fire-resisting floor used to separate one fire compartment from another and having a minimum period of resistance of 60 minutes.

**Compartment wall:** a fire-resisting wall used to separate one fire compartment from another and having a minimum period of resistance of 60 minutes (or 30 minutes in single-storey buildings).

**Emergency lighting:** lighting provided for use when the power supply to the normal lighting fails.

**Escape lighting:** that part of the emergency lighting which is provided to ensure that the escape routes are illuminated at all material times.

**Final exit:** the termination of an escape route from a building giving direct access to a place of safety outside the building.

**Fire-and-smoke damper:** fire-and-smoke damper, triggered by AFD, which, when tested in accordance with BS EN 1366-2, meets the ES classification requirements defined in BS EN 13501-3:2005 and achieves the same fire resistance in relation to integrity as the element of the building construction through which the duct passes.

### Note

Intumescent fire-and-smoke dampers may be tested to ISO 10294-5.

**Fire containment air transfer grille:** a device that will allow the passage of air in normal use, but when activated will contain the passage of fire and hot smoke.

**Fire door:** a door or shutter provided for the passage of persons, air or objects, which, together with its frame and furniture as installed in a building, is intended when closed to resist the passage of fire and/or gaseous products of combustion and is capable of meeting specified

performance criteria to those ends. (It may have one or more leaves, and the term includes a cover or other form of protection to an opening in a fire-resisting wall or floor, or in a structure surrounding a protected shaft.)

**Fire engineering:** the application of scientific and engineering principles to the protection of people, property and the environment from fire.

**Fire hazard:** a set of conditions in the operation of a product or system with the potential for initiating a fire.

**Fire hazard room:** a room or other area which, because of its function and/or contents, presents a greater hazard of fire occurring and developing than elsewhere.

**Fire resistance:** the ability of an element of building construction, a component or a structure to fulfil, for a stated period of time, the required load-bearing capacity, fire integrity and/or thermal insulation and/or other expected duty in a standard fire resistance test.

**Fire stop:** a seal provided to close an imperfection of fit or design tolerance between elements or components, to restrict the passage of fire and smoke.

**Healthcare building:** a hospital, treatment centre, health centre, clinic, surgery, walk-in centre or other building where patients are provided with medical care by a clinician.

**Height of a building (or storey):** the distance from ground level at the lowest side of the building measured to the finished floor level of the top storey.

**Hospital street:** a special type of compartment that connects final exits, stairway enclosures and department entrances, and serves as a fire-fighting bridgehead and a safe evacuation route for occupants to parts of the building unaffected by fire.

**Material of limited combustibility:** either:

- a non-combustible material; or

- any material of density 300 kg/m<sup>3</sup> or more which, when tested in accordance with BS 476-11, does not flame, and whose rise in temperature on the furnace thermocouple is not more than 20°C; or
- any material with a non-combustible core of 8 mm thickness or more, having combustible facings (on one or both sides) not more than 0.5 mm thick; or
- any material of density less than 300 kg/m<sup>3</sup> which, when tested in accordance with BS 476-11, does not flame for more than 10 seconds and whose rise in temperature is not more than 35°C on the centre (specimen) thermocouple and not more than 25°C on the furnace thermocouple.

**Non-combustible:** any material which is capable of satisfying the performance requirements specified in BS 476-4, or any material which when tested in accordance with BS 476-11 does not flame or cause any rise in temperature on either the centre (specimen) or furnace thermocouple.

**Patient-access areas:** those areas of the healthcare building to which patients have reasonable access either with or without supervision.

**Place of safety:** a place where persons are in no danger from fire.

**Progressive horizontal evacuation:** evacuation of patients away from a fire into a fire-free compartment or sub-compartment on the same level.

**Protected shaft:** a shaft that enables persons, air or objects to pass from one compartment to another, and which is enclosed with fire-resisting construction.

**Protected stairway:** a stairway discharging through a final exit to a place of safety

(including any exit route between the foot of the stairway and the final exit) that is adequately enclosed in fire-resisting construction.

**Refuge:** a place of temporary safety within a building. This may be an adjoining compartment or sub-compartment capable of holding all those threatened, without a significant change in level and from which there is potential for further escape should that become necessary.

**Relevant boundary:**

- a. the actual boundary of the premises; or
- b. the boundary of the site which the side of the building faces, and which is parallel, or at an angle of not more than 80°, to the side of the building; or
- c. the centre line of a road, railway, river or canal that adjoins the actual boundary; or
- d. a notional boundary established between buildings, if two or more buildings share the same site.

**Swing beds:** Single-bed rooms located in such a manner that they can be part of either the “male wing” or the “female wing”. Swing beds are generally provided where sleeping accommodation is segregated by sex, and then only in facilities providing in-patient mental health services or accommodation for people with learning disabilities.

**Smoke-retarding construction:** construction intended to retard the passage of smoke.

In the absence of an appropriate method of test and performance criteria, such construction should not contain unsealed joints and permanently open or openable areas. Joints between such construction and any abutting element should be tight and preferably sealed with a filler conforming to BS EN 1366-3 or BS EN 1366-4 (for example plaster), a mastic, or a flexible strip (for example neoprene), as appropriate.

Any doors located within smoke-retarding construction, when tested in accordance with BS 476-31.1 with the threshold taped, and subjected to a pressure of 25 Pa, should have a leakage rate not exceeding 3 m<sup>3</sup>/h per metre.

**Sub-compartments:** areas into which the building can be divided to reduce travel distance and which provide 30 minutes' resistance to fire.

**Sub-compartment wall:** a fire-resisting wall used to separate one sub-compartment from another and having a minimum period of fire resistance of 30 minutes.

**Travel distance:** the horizontal distance to be travelled by a person from any point within the floor area to the nearest adjoining compartment, sub-compartment, escape stairway or external exit, having regard to the layout of walls, partitions, fittings and furniture.

**Unprotected area:** in relation to a side or external wall of building, this means:

- window, door or other opening; and
- any part of an external wall which has a period of fire resistance less than that required for the elements of structure (integrity and load-bearing capacity only), and which provides less than 15 minutes' fire resistance (insulation); and
- any part of the external wall which has combustible material more than 1 mm thick attached or applied to its external face, whether for cladding or any other purpose. (Combustible material in this context is a material which is neither "non-combustible" nor a "material of limited combustibility".)

## Appendix B: Periods of fire resistance

The performance of those elements of the building which are required to achieve a specified period of fire resistance is determined by reference to BS 476-20–24:1987. Performance is assessed against one or more of the following criteria:

- resistance to collapse (load-bearing capacity), which applies to load-bearing elements;
- resistance to fire penetration (integrity), which applies to fire-separating elements;

- resistance to the transfer of excessive heat (insulation), which applies to fire-separating elements.

Table B1 summarises the specific requirements for each element in terms of the three performance requirements above.

A suspended ceiling should not be relied upon to contribute to the fire resistance of a compartment floor.

**Table B1 Periods of fire-resistance**

Part of building	Minimum provisions when tested to the relevant part of BS 476 <sup>1</sup> (minutes)			Minimum provisions when tested to the relevant European standard <sup>3</sup>	Method of exposure
	Load-bearing capacity <sup>2</sup>	Integrity	Insulation		
Structural frame, beam or column	See Table 5	Not applicable	Not applicable	R (see Table 5)	Exposed faces
Load-bearing wall	See Table 5	Not applicable	Not applicable	R (see Table 5)	Each side separately
Compartment floor <sup>4,5</sup>	60	60	60	REI 60	From the underside
Compartment wall <sup>6</sup> Single-storey buildings	Not applicable	60 <sup>7</sup>	60 <sup>7</sup>	EI 60	Each side separately
		30	30	EI 30	
Sub-compartment wall <sup>6</sup>	Not applicable	30	30	EI 30	Each side separately
Wall to a fire hazard room	Not applicable	30	30	EI 30	Each side separately
Protected shaft	60	60	60	REI 60	Each side separately
Fire-fighting shafts	120	120	120	REI 120	From side remote from shaft
1. construction separating the shaft from the building	60	60	60	REI 60	From shaft side
2. construction separating fire-fighting stairway from the fire-fighting lift shaft and fire-fighting lift lobby	60	60	60	REI 60	Each side separately
Cavity barrier <sup>8</sup>	Not applicable	30	15	E 30 and EI 15	Each side separately
Fire-resisting ceiling (as described in paragraph 5.42)	Not applicable	30	30	EI 30	From the underside

**Notes:**

1. BS 476-21 for load-bearing elements; BS 476-22 for non-load-bearing elements; BS 476-23 for fire-protecting suspended ceilings; and BS 476-24 for ventilation ducts.  
BS 476-8 results are acceptable for items tested or assessed before 1 January 1988.
2. Applies to load-bearing elements only (see B3.ii and Appendix E of Approved Document B).
3. The national classifications do not automatically equate with the equivalent classifications in the European column; therefore, products cannot typically assume a European class unless they have been tested accordingly.
  - “R” is the European classification of the resistance to fire performance in respect of load-bearing capacity;
  - “E” is the European classification of the resistance to fire performance in respect of integrity; and
  - “I” is the European classification of the resistance to fire performance in respect of insulation.
4. See Table 5 for floors that are over 12 m and 30 m above ground level.
5. Guidance on increasing the fire resistance of existing timber floors is given in BRE Digest 208 – ‘Increasing the fire resistance of existing timber floors’.
6. Except for any limitations on glazed elements.
7. May be reduced if sprinklers are installed.
8. For the purposes of meeting the Building Regulations, cavity barriers will be deemed to have satisfied the provisions above, provided that they achieve an integrity requirement of at least 30 minutes and an insulation requirement of at least 15 minutes.



## Appendix C: Doors and doorsets

Fire doors should have the appropriate performance as indicated in Table C1. In

the table the doors are identified by their performance under BS 476-22 in terms of

**Table C1** Location of fire doors

Location of door	Minimum period of fire resistance in terms of integrity (minutes) when tested to BS 476-22 <sup>1</sup>	Minimum period of fire resistance in terms of integrity (minutes) when tested to European standards <sup>2</sup>
<b>Sub-compartment wall</b>	FD30S	E30 S <sub>a</sub>
<b>Fire hazard rooms</b>	FD30S	E30 S <sub>a</sub>
<b>In a compartment wall</b>	FD30S – Single-storey healthcare buildings	E30 S <sub>a</sub>
	FD30S – Storeys above ground in healthcare buildings fitted with sprinklers	E30 S <sub>a</sub>
	FD60S – elsewhere	E60 S <sub>a</sub>
<b>To a protected shaft containing a stairway or escalator:</b>		
<b>a. accessed from a hospital street</b>	FD30S	E30 S <sub>a</sub>
<b>b. elsewhere</b>	FD30S to each of the two sets of doors to the lobby	E30 S <sub>a</sub>
<b>To a protected shaft containing a lift<sup>3</sup>:</b>		
<b>a. accessed from a hospital street</b>	FD30	E30
<b>b. elsewhere</b>	FD30S to the doors from the circulation space to the lobby	E30 S <sub>a</sub>
	FD30 from the lift car to the lobby	E30
<b>To a protected shaft containing chutes, ducts and pipes</b>	FD60S	E60 S <sub>a</sub>
<b>Within a cavity barrier</b>	FD30*	E30

**Notes:**

1. To BS 476-22 (or BS 476-8 subject to paragraph 5 in Appendix A of Approved Document B).

2. The national classifications do not automatically equate with the equivalent classifications in the European column; therefore, products cannot typically assume a European class unless they have been tested accordingly.

Unless pressurisation techniques complying with BS EN 12101-6:2005 are used, all these doors (except those marked \*) should also either:

(a) have a leakage rate not exceeding 3 m<sup>3</sup>/m/hour (head and jambs only) when tested at 25 Pa under BS 476-31.1; or

(b) meet the additional classification requirement of S<sub>a</sub> when tested to BS EN 1634-3.

3. Lift doors to be tested to BS EN 81-58.

integrity for a period of minutes (for example FD30). A suffix (S) is added for doors where restricted smoke leakage at ambient temperatures is needed. Unless pressurisation techniques complying with BS EN 12101-6:2005 are used, doors with the suffix “S” should also have a leakage rate not exceeding 3 m<sup>3</sup>/m/hour (head and jambs only) when tested at 25 Pa under BS 476-31.1. The method of test exposure is from each side of the doors separately, except in the case of lift doors, which are tested from the landing side only.

## Door closers

Generally all fire doors should be fitted with an automatic self-closing device complying with BS EN 1154 or BS EN 1634-1, with the following exceptions:

- fire doors to patients’ bedrooms in facilities providing in-patient mental health services;
- fire doors to bedrooms in in-patient accommodation for people with learning disabilities; and
- fire doors which are kept locked shut.

With the exception of doors to stairways, it may be acceptable for fire doors to be held open on electrically operated door-release mechanisms provided that all of the following criteria can be satisfied:

- the door-release mechanism should conform to BS 5839-3:1988 and BS 7273-4:2007 and be fail-safe (that is, in the event of a fault or loss of power, the release mechanism should be triggered automatically);
- all doors fitted with automatic door releases should be linked to the fire detection and alarm system;
- all automatic door releases within a compartment/sub-compartment

should be triggered by any of the following:

- the actuation of any automatic fire detector within the compartment/sub-compartment;
- the actuation of any manual fire-alarm call point within the compartment/sub-compartment;
- any fault in the fire warning system within the compartment/sub-compartment;
- any loss of power to the fire warning system;
- automatic door releases must be provided with a ready means of manual operation from a position at the door;
- each door fitted with an automatic door release should be closed at a predetermined time each night and remain closed throughout sleeping hours. If for reasons of management this is impracticable, it should be the specific responsibility of the fire warden (or other nominated member of staff) to operate the release mechanism at least once a week to ensure that:
  - the mechanism is working effectively;
  - the doors close effectively onto their frames.

Please note: the installation and operation of electro-magnetic hold open/swing free door closers should also satisfy similar criteria.

## Identification

All fire doors, including each leaf of double doors, should be provided with an identification disc (except in mental health accommodation). The disc should be a minimum of 45 mm in diameter, clearly indicating the fire-resisting

standard of the door (for example FD30s, FD60s etc).

## Doors on escape routes

Fire doors on escape routes should be side-hung or pivoted. Revolving doors should be avoided, but where they are used, they must easily convert to outward-opening doors; or there should be outward-opening doors adjacent to the revolving door, capable of allowing safe egress for the numbers of persons likely to use them. Turnstiles and shutters are not acceptable on escape routes and should not be used.

Sliding doors are acceptable on escape routes provided they convert to outward-opening doors when subjected to reasonable pressure from any direction. In the case of powered sliding doors, they should in addition be provided with a monitoring system to ensure that they fail-safe to the fully open position in the event of a power failure.

Door swings should not obstruct the circulation space or the designed width of the escape route. However, doors to cupboards etc that are normally locked may open onto circulation routes, but it is recommended that such doors should open through 180° to avoid obstruction.

Fire doors across escape routes providing alternative means of escape must be double-swing, and those across escape routes providing single direction of escape should open in the direction of escape.

Fire-exit doors to rooms containing more than 60 people should open outwards from the room. Door swing direction for escape routes within mental health facilities should be reviewed on a risk assessment basis.

Fire doors across circulation routes should be fitted with glazed observation panels to a height of 500 mm above the threshold of the door.

## Appendix D: Thermoplastic materials

A thermoplastic material means any synthetic polymeric material which has a softening point below 200°C if tested to BS EN ISO 306:2004. Specimens for this test may be fabricated from the original polymer where the thickness of material of the end product is less than 2.5 mm.

A thermoplastic material in isolation cannot be assumed to protect a substrate when used as a lining to a wall or ceiling. The surface rating of both products must therefore meet the required classification. If, however, the thermoplastic material is fully bonded to a non-thermoplastic substrate, only the surface rating of the composite will need to comply.

Concessions are made for thermoplastic materials used for windows, roof lights and lighting diffusers. They are described in [paragraphs 4.6–4.12](#).

For the purposes of [paragraphs 4.1–4.12](#), either:

- thermoplastic materials should be used according to their classification 0–3 under the tests in BS 476-6 and BS 476-7 (if they have such a rating); or
- they may be classified TP(a) rigid, TP(a) flexible, or TP(b) according to the following methods.

### TP(a) rigid

- (i) rigid solid pvc sheet;

- (ii) solid (as distinct from double- or multi-skinned) polycarbonate sheet at least 3 mm thick;
- (iii) multi-skinned rigid sheet made from unplasticised pvc or polycarbonate which has Class 1 rating when tested to BS 476-7:1971, 1987 or 1997; or
- (iv) any other rigid thermoplastic product, a specimen of which when tested to BS 2782-0:2004 Method 508 performs so that the test flame extinguishes before the first mark, and the duration of flaming or afterglow does not exceed five seconds following removal of the burner.

### TP(a) flexible

- (i) These are flexible products not more than 1 mm thick which comply with the Type C requirements of BS 5867-2 when tested to BS 5438, Test 2, 1989, with the flame applied to the surface of the specimens for 5, 15, 20 and 30 seconds respectively, but excluding the cleansing procedure.

### TP(b)

- (i) rigid solid polycarbonate sheet products less than 3 mm thick, or multi-skinned polycarbonate sheet

products which do not qualify as TP(a) by test; or

- (ii) other products which, when a specimen of the material between 1.5 and 3 mm thick is tested in accordance with BS EN ISO 306:2004, have a rate of burning

that does not exceed 50 mm/minute. (If it is not possible to cut or machine a 3 mm thick specimen from the product, a 3 mm test specimen can be moulded from the same material as that used for the manufacture of the product.)

## Appendix E: Construction and fixing of cavity barriers

Every cavity barrier should be constructed to provide at least 30 minutes' fire resistance except for a cavity barrier in a stud wall or partition, which may be formed of:

- a. steel at least 0.5 mm thick; or
- b. timber at least 38 mm thick; or
- c. polythene-sleeved mineral wool or mineral wool slab – in either case under compression when installed in the cavity; or
- d. calcium silicate (cement-based or gypsum-based boards at least 12.5 mm thick).

A cavity barrier may be formed by any construction provided for another purpose if it meets the provisions for cavity barriers.

Cavity barriers should be tightly fitted to rigid construction and mechanically fixed in position wherever possible. Where this is not possible (for example in the case of a junction with slates, tiles, corrugated sheeting or similar materials), the junction should be fire-stopped.

Cavity barriers should also be fixed so that their performance is unlikely to be made ineffective by:

- a. movement of the building due to subsidence, shrinkage or temperature change, and movement of the external envelope due to wind;
- b. collapse in a fire of any services penetrating them;
- c. failure in a fire of their fixings; or
- d. failure in a fire of any material or construction which they abut. For example, if a suspended ceiling is continued over the top of a fire-resisting wall or partition, and direct connection is made between the ceiling and the cavity barrier above the line of the wall or partition, premature failure of the cavity barrier can occur when the ceiling collapses. However, this does not arise if the ceiling is designed to provide fire protection of 30 minutes or more.

# Appendix F: Fire behaviour of insulating core panels

## Introduction

Insulating core panel systems are used for external cladding as well as for internal structures. However, while both types of panel system have unique fire behaviour characteristics, both can present particular problems with regard to fire spread.

Panels typically consist of an inner core sandwiched between, and bonded to, a membrane such as facing sheets of galvanised steel. The panels are then formed into a structure by jointing systems, usually designed to provide an insulating and/or hygienic performance. The panel structure can be free-standing, but is usually attached to the building structure by lightweight fixings and hangers.

The most common forms of insulation in present use are:

- expanded polystyrene;
- extruded polystyrene;
- polyurethane; and
- mineral fibre.

However, panels with the following core materials are also in use:

- polyisocyanurate; and
- modified phenolic.

Unlike other buildings, healthcare premises (in particular hospitals) often utilise progressive horizontal evacuation rather than total building evacuation. Selecting the appropriate insulated core products for internal walls or partitions, or for external cladding material, is vital for patient and building occupant safety.

## Fire behaviour of the core materials and fixing systems

The use of cladding panels for both internal and external walls can produce a significant risk to the occupants of healthcare buildings, in particular in-patients who may be dependent on staff for evacuation. In considering the use of such cladding, reference should be made to the requirements of Approved Document B. The panel in-fill material, when involved in a fire, should not compromise the safety of occupants remaining in the building either through fire or through smoke spread.

When compared with other types of construction technique, these panel systems therefore provide a unique combination of problems for firefighters, including:

- hidden fire spread within panels with thermoplastic cores;
- production of large quantities of black toxic smoke;
- rapid fire spread leading to flashover; and

- they are hidden fire behind lining systems.

Wherever possible, cladding with a non-combustible core should be used.

## Design recommendations

To identify the appropriate solution, a risk assessment approach should be adopted. This would involve identifying the potential fire risk within the enclosures formed by the panel systems and then adopting one or more of the following at the design stage:

- removing the risk;
- separating the risk from the panels by an appropriate distance;
- providing a fire suppression system for the risk;
- providing a fire suppression system for the enclosure;
- providing fire-resisting panels;
- specifying appropriate materials/fixing and jointing systems.

In summary, the performance of the building structure, including the insulating envelope, the superstructure, the substructure etc, must be considered in relation to their performance in the event of a fire.

## Specifying panel core materials

Where at all possible, the specification of panels with core materials appropriate to the application will help to ensure an acceptable level of performance for panel systems when involved in fire conditions.

The following are examples of core materials that may be appropriate to the application concerned.

- Mineral fibre cores
  - (i) cooking areas;

- (ii) hot areas;
- (iii) fire breaks in combustible panels;
- (iv) fire-stop panels;
- (v) general fire protection;
- (vi) external cladding.

- All cores
  - (i) chill stores;
  - (ii) cold stores;
  - (iii) clean rooms.

## General

Generally, panels or panel systems should not be used to support machinery or other permanent loads. Any cavity created by the arrangement of panels, their supporting structure or other building elements should be provided with suitable cavity barriers.

Examples of possible solutions and general guidance on insulating core panel construction can be found in the International Association for Cold Storage Construction (European Division)'s 'Design, construction, specification and fire management of insulated envelopes for temperature controlled environments'. While this document is primarily intended for use in relation to cold storage environments, the guidance, particularly in Chapter 8, is considered to be appropriate for most insulating core panel applications.

### Note

Core materials may be used in other circumstances where a risk assessment has been made and other appropriate fire precautions have been put in place.



# Appendix G: Fire drawings

## Provision of drawings

The following information should be provided as drawings to assist the responsible persons to operate, maintain and use the building in reasonable safety and to assist the eventual owner, occupier and/or employer to meet their statutory duties under the Regulatory Reform (Fire Safety) Order. This is considered best practice to comply with regulation 38 of the Building Regulations.

An as-built plan of the building should be provided showing:

- a. escape routes;
- b. compartmentation and separation (that is, location of fire-separating elements including cavity barriers in walk-in spaces);
- c. fire doors, self-closing fire doors and other doors equipped with relevant hardware (for example panic locks);
- d. locations of fire and/or smoke detector heads, alarm call-points, detection/alarm control boxes, alarm sounders, alarm zones and Cause and Effect, fire safety signage, emergency lighting, fire extinguishers, dry or wet risers and other fire-fighting equipment, and location of hydrants outside the building;
- e. any sprinkler system(s), including isolating valves and control equipment;
- f. any smoke-control system(s) (or ventilation system with a smoke-control function), including mode of operation, control systems and inlet air routes, and fire-and-smoke damper locations and HVAC routing;
- g. any high-risk areas (for example heating machinery);
- h. specifications of any fire safety equipment provided, in particular any routine maintenance schedules; and
- i. any assumptions in the design of the fire safety arrangements regarding the management of the building.

## Fire drawings

To adequately assess the fire precautions at design stage, a set of fire drawings should be prepared using symbols based on BS 1635.

In order to adequately assess compliance with the requirements of this guidance, the drawings should show in sufficient detail the detection and alarm systems, the means of escape, the structural fire precautions, the portable and fixed fire-fighting equipment, smoke control/ventilation arrangements, and access and facilities for the fire-and-rescue service.

A typical set of fire drawings would comprise:

- a. a location plan;
- b. a site plan;

- c. a floor plan of each storey, prepared at a scale of not less than 1:200; completion, an as-built set of drawings can be prepared.
- d. a floor plan of each department, prepared at a scale of not less than 1:100 and preferably at a scale of 1:50; and The as-built drawings should be held by the trust so that any proposed future alterations can be checked against the fire drawings to ensure that the integrity of fire safety is maintained in accordance with the recommendations in this document.
- e. a set of elevations.

During the construction of a project, variations to the structure and the layout frequently occur; these variations should not subvert the integrity of the agreed fire precautions. The variations should be recorded on the fire plans so that on

This is an operational requirement and cannot be enforced through the current Building Regulations.

# Appendix H: Care Quality Commission types of service

## Healthcare services

Code	Service type
ACS	<p><b>Acute services</b></p> <p>These services are complex and vary greatly. Generally, however, they provide medical and/or surgical investigations, diagnosis and treatment for physical illness or condition, injury or disease. They can provide services to adults, children or both. They may provide services to a broad range of people or to a particular group of people.</p> <p>They can:</p> <ul style="list-style-type: none"> <li>• admit people on a day case basis or as in-patients;</li> <li>• admit people at short notice or in an emergency (whether or not they have a dedicated emergency department);</li> <li>• see people on an out-patient basis.</li> </ul> <p>They may also provide services such as:</p> <ul style="list-style-type: none"> <li>• Surgical operations</li> <li>• Specialist medical treatments</li> <li>• Emergency</li> <li>• Consultations</li> <li>• Diagnostics</li> <li>• Maternity and neonatal</li> <li>• Pathology</li> <li>• Termination of pregnancy</li> <li>• Complex dental procedures</li> <li>• Liaison psychiatry.</li> </ul> <p>People are usually admitted to the service under the care of a medical or clinical practitioner. The service may also employ a broad range of healthcare professionals to meet the needs of the people using the service.</p> <p>Some services may be smaller than others and may not provide the same range of acute services as, say, a local district hospital may offer (such as an emergency department).</p> <p><b>Examples of services that fit under this category</b></p> <ul style="list-style-type: none"> <li>• Acute NHS hospitals</li> <li>• Acute independent hospitals</li> <li>• Termination of pregnancy clinics</li> <li>• NHS community hospitals</li> <li>• Independent sector treatment centres (ISTCs)</li> <li>• Community hospitals</li> <li>• Cosmetic surgery clinics</li> <li>• Specialist or single specialty hospitals</li> <li>• Maternity hospitals</li> <li>• IVF clinics providing surgical treatment or endoscopy</li> <li>• Haemodialysis units</li> <li>• Minor injuries units</li> </ul>

Code	Service type
HBC	<p><b>Hyperbaric chamber services</b></p> <p>These services involve the administration of oxygen (whether or not combined with one or more other gases) to a person in a sealed chamber that is gradually pressurised with compressed air. The services are carried out by, or under the supervision of, a medical practitioner.</p> <p>The services help to treat a range of medical conditions including:</p> <ul style="list-style-type: none"> <li>• air or gas embolism</li> <li>• decompression illness</li> <li>• carbon monoxide poisoning</li> <li>• gas gangrene</li> <li>• necrotising fasciitis</li> <li>• other conditions approved by the Undersea and Hyperbaric Medical Society.</li> </ul> <p><b>Examples of services that fit under this category</b></p> <ul style="list-style-type: none"> <li>• Type 1 hyperbaric chambers</li> <li>• Type 2 hyperbaric chambers</li> </ul>
HPS	<p><b>Hospice services</b></p> <p>These provide a range of services for conditions where curative treatment is no longer an option, and people are approaching the end of their life. They provide care, treatment and support for people and their families and carers, including respite care for people who live with friends or family at home.</p> <p>Care, treatment and support can be provided in accommodation or in the community. It can be long- or short-term care, on an in-patient basis or provided through day care, day therapy or outreach services.</p> <p>The services will generally employ or work with a broad range of health and social care professionals to meet the needs of people using the service.</p> <p><b>Examples of services that fit under this category</b></p> <ul style="list-style-type: none"> <li>• Adult hospices</li> <li>• Children’s hospices</li> <li>• Day hospices</li> <li>• End-of-life care teams</li> <li>• Hospice at home</li> </ul>
LTC	<p><b>Long-term conditions</b></p> <p>These services provide a range of care, treatment and support to people with physical or neurological illnesses, cognitive impairments or injuries that are unlikely to improve. These conditions may have been inherited or acquired, and may not necessarily be life-limiting. This care, treatment and support is the sole or main purpose of the service.</p> <p>People may be cared for by these services for many years at a time, and will be “admitted” and stay at the facility over time. People using these services require the support of medical practitioners and a range of other healthcare professionals, and their care, treatment and support may involve highly technical interventions such as ventilation.</p>
MLS	<p><b>Hospital services for people with mental health needs, and/or learning disabilities, and/or problems with substance misuse</b></p> <p>These services are for people with mental health needs or learning disabilities, who are admitted to hospital, involving an overnight stay, for assessment or treatment when there is a need for more intensive support than would typically be provided in the community, or a need for a specialist assessment or intervention.</p> <p>This usually occurs due to:</p> <ul style="list-style-type: none"> <li>• an acute episode of a severity that requires 24-hour care;</li> <li>• a need for a higher level of security;</li> <li>• a need for a specialist assessment, treatment and/or rehabilitation.</li> </ul> <p>This might include providing care, treatment and support for people detained under the Mental Health Act 1983.</p> <p>Some people with mental health needs or a learning disability may require longer-term accommodation in hospital, while others may be admitted for short periods or treated on a day case basis.</p> <p>These services <b>also</b> cover in-patient treatment for people with <b>problems with substance misuse</b>. They usually involve short periods of hospital-based treatment, including 24-hour medical cover to assess and stabilise the person, and treatment for withdrawal from drugs (legal, illegal and substitute preparations) or detoxification from alcohol.</p> <p>All the hospital services above will usually comprise one or more wards in which care, treatment and support are provided. There may be a range of other facilities including occupational and arts therapies, psychological therapies, psychosocial interventions, recreational activities and services to address physical health needs.</p> <p><b>Examples of services that fit under this category</b></p> <ul style="list-style-type: none"> <li>• NHS or independent services that provide specialist hospital services for people with mental health needs, learning disabilities and problems with substance misuse</li> <li>• Child and adolescent mental health services (CAMHS) tier 4</li> </ul>

Code	Service type
RHS	<p data-bbox="244 232 890 259"><b>Residential substance misuse treatment/rehabilitation services</b></p> <p data-bbox="244 275 1465 383">These services provide, as their sole or main purpose, treatment to people following an illness or injury that impairs their physical, mental or cognitive wellbeing, but for which continued rehabilitative care is likely to bring about improvement. They may consist of a range of services that promote faster recovery from illness, prevent unnecessary admission to acute services, support timely discharge and maximise independent living.</p> <p data-bbox="244 398 1465 450">The services can be provided on a short- or long-term basis, in hospital, residential, day care or domiciliary settings. They are mainly provided within healthcare settings but can also be provided in a social care setting.</p> <p data-bbox="244 465 740 492"><b>Examples of services that fit under this category</b></p> <ul data-bbox="256 508 544 562" style="list-style-type: none"> <li data-bbox="256 508 544 535">• Intermediate care schemes</li> <li data-bbox="256 535 544 562">• Rehabilitation units</li> </ul>
RSM	<p data-bbox="244 575 890 602"><b>Residential substance misuse treatment/rehabilitation services</b></p> <p data-bbox="244 618 1465 725">These services are provided to adults and children who have problems with misusing drugs and/or alcohol. They provide care, treatment and support, both pharmacological and psychosocial, and help people to reintegrate into their communities, focusing on the coping strategies and life skills they need to do this. They employ a broad range of health and social care professionals to meet the needs of people who use their services.</p> <p data-bbox="244 741 1465 792">Some of these services may also provide assessment, stabilisation and treatment for withdrawal from drugs (legal, illegal and substitute preparations) or detoxification from alcohol.</p> <p data-bbox="244 808 740 835"><b>Examples of services that fit under this category</b></p> <ul data-bbox="256 851 1038 936" style="list-style-type: none"> <li data-bbox="256 851 1038 878">• Residential substance misuse rehabilitation services</li> <li data-bbox="256 878 1038 904">• Crisis intervention units</li> <li data-bbox="256 904 1038 936">• Care homes providing accommodation for the treatment of substance misuse</li> </ul>
DTS	<p data-bbox="244 949 531 976"><b>Doctors' treatment services</b></p> <p data-bbox="244 992 1465 1099">These services involve doctors working in premises, or a room, designated for minor medical treatments as well as medical consultation. Often the doctor will complete medical consultations, including physical examination and simple physiological measurement (such as blood pressure tests). They will discuss diagnosis and treatment options and may prescribe medicines for the person to take at home.</p> <p data-bbox="244 1115 1465 1167">They will also undertake minor invasive investigations or procedures, such as conscious endoscopy, in a treatment room designed for this purpose.</p> <p data-bbox="244 1182 1230 1209">There may be other healthcare professionals, for example nurses, supporting the work of the doctor.</p> <p data-bbox="244 1225 740 1252"><b>Examples of services that fit under this category</b></p> <ul data-bbox="256 1267 667 1397" style="list-style-type: none"> <li data-bbox="256 1267 667 1294">• Independent doctors' consulting rooms</li> <li data-bbox="256 1294 667 1321">• NHS GP practices</li> <li data-bbox="256 1321 667 1348">• Early medical abortion clinics</li> <li data-bbox="256 1348 667 1375">• Travel vaccination services</li> <li data-bbox="256 1375 667 1397">• Polyclinics</li> </ul>

Code	Service type
DSS	<p data-bbox="212 226 592 253"><b>Diagnostic and/or screening services</b></p> <p data-bbox="212 271 1070 297">These services provide individual health assessment and/or screening to people, using:</p> <ul data-bbox="225 315 651 600" style="list-style-type: none"> <li>• Diagnostic imaging, such as:                             <ul data-bbox="308 338 651 495" style="list-style-type: none"> <li>X-rays</li> <li>Computed tomography (CT)</li> <li>Magnetic resonance imaging (MRI)</li> <li>Ultrasound scanning</li> <li>Gamma cameras</li> <li>PET scanners</li> </ul> </li> <li>• Pathology</li> <li>• Physiological measurement</li> <li>• Genetic and screening services</li> <li>• Endoscopy.</li> </ul> <p data-bbox="212 622 1406 696">They provide, as the sole or main purpose, diagnosis or screening. They do not usually provide any other health or social care services. While large acute hospitals will have similar services, this category relates only to these dedicated, focused services.</p> <p data-bbox="212 719 1414 768">These services undertake investigations on behalf of the person using the service or on behalf of a healthcare professional that the person is consulting (who is legally permitted to request such investigations).</p> <p data-bbox="212 790 895 817">They will involve a range of healthcare professionals that may include:</p> <ul data-bbox="225 835 639 936" style="list-style-type: none"> <li>• Medical practitioners</li> <li>• Nurses</li> <li>• Radiographers</li> <li>• Physiological measurement technicians.</li> </ul> <p data-bbox="212 954 703 981"><b>Examples of services that fit under this category</b></p> <ul data-bbox="225 999 703 1122" style="list-style-type: none"> <li>• Health screening centres</li> <li>• MRI or CT scanning services (fixed and mobile)</li> <li>• Baby scanning services</li> <li>• Endoscopy centres and clinics</li> <li>• Stand-alone or mobile urodynamic services</li> </ul>
UCS	<p data-bbox="212 1144 424 1171"><b>Urgent care services</b></p> <p data-bbox="212 1189 1401 1238">These services are provided in parallel with an emergency department and vary greatly from one service to another. They generally comprise a triage service, run by doctors and nurses.</p> <p data-bbox="212 1261 1417 1335">They will not usually screen people whose symptoms require immediate, very urgent or emergency care. Instead, they screen standard cases where time is not of the essence, and where possible refer these for immediate consultation with an on-site primary care provider.</p> <p data-bbox="212 1357 560 1384">They may provide services such as:</p> <ul data-bbox="225 1402 967 1525" style="list-style-type: none"> <li>• consultations with a doctor</li> <li>• physical examinations and simple physiological testing and measurement</li> <li>• diagnosis and treatment</li> <li>• prescribing medicines</li> <li>• referrals to other primary care services.</li> </ul> <p data-bbox="212 1543 703 1570"><b>Examples of services that fit under this category</b></p> <ul data-bbox="225 1588 600 1688" style="list-style-type: none"> <li>• Primary care trust emergency triage</li> <li>• Urgent care triage</li> <li>• Primary care access centre</li> <li>• Walk-in clinic</li> </ul>

# Appendix J: Qualitative Design Review

Because of the complex and changing nature of healthcare and the often conflicting requirements between fire safety and nursing care etc, it is therefore essential that early consultation takes place between all relevant parties; ideally this consultation should form a Qualitative Design Review, as detailed in PD 7974-0:2002, 'Application of fire safety engineering principles to the design of buildings – Part 0: Guide to design framework and fire safety engineering procedures'. The following information has been taken from the aforementioned PD 7974:0: 2002.

The QDR is essentially a qualitative process that draws upon the experience and knowledge of the fire safety engineer and a team of others involved in the design and operation of the building.

For very large and complex projects, it is recommended that the QDR be carried out by a study team involving one or more fire safety engineers, other members of the design team and a member of operational management. It might also be appropriate to include representatives of approval bodies or the insurers to ensure that their views can be accounted for.

The QDR team on a major project might include the following:

- a. fire safety engineer (chair);
- b. client user group – generally involving clinicians, nurses, managers, estates or

facilities managers and the fire safety advisor;

- c. design team – architects and engineers;
- d. fire service representative; and
- e. building control or approved inspector.

The QDR is a structured technique that allows the team to think of the possible ways in which a fire hazard might arise and establish a range of strategies to maintain the risk at an acceptable level. The fire safety design can then be evaluated quantitatively or qualitatively against the objectives and criteria set by the team. The QDR should be conducted in a systematic way to reduce the chance of a relevant item being missed.

Whilst the QDR is essentially a qualitative process, it can often be useful to carry out quick calculations to resolve a difference of opinion between team members or to establish the most significant scenarios for detailed quantification.

The main stages in the QDR are:

- a. review architectural design and occupant characteristics;
- b. establish fire safety objectives;
- c. identify fire hazards and possible consequences;
- d. establish trial fire safety designs;

- e. identify acceptance criteria and methods of analysis;
- f. establish fire scenarios for analysis.

All findings should be clearly recorded so that the underlying philosophy and assumptions that underpin the FSE study are explicit and can be readily checked by a third party. This information should be contained in the Fire Safety Strategy for the premises. Information provided to support Regulation 38 should include the following information. The reader should note that the information detailed below is only intended as guidance; however, the level of detail required will vary from building to building and should be considered on a case-by-case basis:

- the fire safety strategy, including all assumptions in the design of the fire safety systems (such as fire load), and any risk assessments or risk analysis;
- all assumptions in the design of the fire safety arrangements regarding the management of the building;
- escape routes (including stairs and lifts), escape strategy (for example simultaneous or phased) and muster points;
- details of all passive and active fire safety measures, including (but not exhaustively):
  - compartmentation (that is, location of fire-separating elements), cavity barriers, fire doors, self-closing fire doors and other doors equipped with relevant hardware (for example electronic security locks), and fire-and-smoke dampers;
  - automatic fire detection systems, emergency communication systems, CCTV, fire safety signage, emergency lighting, fire extinguishers;
  - dry or wet risers and other fire-fighting equipment, other interior facilities for the fire-and-rescue service, emergency control rooms, location of hydrants outside the building, and other exterior facilities for the fire-and-rescue service;
  - sprinkler system(s) design, including isolating valves and control equipment; and
  - smoke-control system(s) (or HVAC system with a smoke-control function) design, including mode of operation and control systems;
- any high-risk areas (for example heating machinery) and particular hazards;
- as-built plans of the building showing the locations of the above;
- specifications of any fire safety equipment provided, including operational details, operator manuals, software, system zoning, routine inspection, and testing and maintenance schedules. Records of any acceptance or commissioning tests;
- any other details appropriate for the specific building;
- findings of the QDR consultation.



# Appendix K: References

## Acts and Regulations

**Building Regulations 2010.** SI 2010 No 2214. HMSO, 2010.

**Building Regulations 2010: Approved Document B: Fire Safety – Volume 2.**

Department for Communities and Local Government, 2006 edition (incorporating 2007, 2010 and 2013 amendments).

**Building Regulations 2000: Approved Document F: Ventilation.** Department for Communities and Local Government, 2010.

**Building Regulations 2000: Approved Document K: Protection from falling, collision and impact.** Department for Communities and Local Government, 2013.

**Regulatory Reform (Fire Safety) Order 2005.** SI 2005 No 541. HMSO, 2005.  
<http://www.opsi.gov.uk/si/si2005/20051541.htm>

## European legislation

**Council Directive 89/106/EEC of 21 December 1988 on the approximation of laws, regulations and administrative provisions of the Member States relating to construction products.** Official Journal of the European Communities. L 40, 11.02.1989, p 12.

**Construction Products Regulations:**  
“REGULATION (EU) No 305/2011 OF THE

EUROPEAN PARLIAMENT AND OF THE COUNCIL of 9 March 2011 laying down harmonised conditions for the marketing of construction products and repealing Council Directive 89/106/EEC. Published in the Official Journal L88, 04 April 2011.”

## Firecode publications

**Health Technical Memorandum 05-01: Managing healthcare fire safety.** Second edition. Department of Health, 2013.

**Health Technical Memorandum 05-03: Part A. General fire safety.** Department of Health, 2013.

**Health Technical Memorandum 05-03: Part B. Fire detection and alarm systems.** The Stationery Office, 2006.

**Health Technical Memorandum 05-03: Part D. Commercial enterprises on healthcare premises.** Second edition. Department of Health, 2013.

**Health Technical Memorandum 05-03: Part E. Escape bed lifts.** The Stationery Office, 2006.

**Health Technical Memorandum 05-03: Part F. The prevention and control of arson in NHS healthcare premises.** Department of Health, 2013.

**Health Technical Memorandum 05-03: Part G. Laboratories on healthcare premises.** The Stationery Office, 2006.

**Health Technical Memorandum 05-03: Part H. Reducing false alarms in healthcare premises.** Department of Health, 2013.

**Health Technical Memorandum 05-03: Part J. Guidance on fire engineering of healthcare premises.** The Stationery Office, 2008.

**Health Technical Memorandum 05-03: Part K. Guidance on fire risk assessments in complex healthcare premises.** Department of Health, 2013.

**Health Technical Memorandum 05-03: Part L. NHS Fire statistics 1994/5–2004/5.** The Stationery Office, 2007.

## Health Building Notes

**Health Building Note 00-04: Circulation and communication spaces.** Department of Health, 2013.

## Health Technical Memoranda

**Health Technical Memorandum 02-01: Medical gas pipeline systems.** The Stationery Office, 2006.

**Health Technical Memorandum 03-01: Specialised ventilation for healthcare premises.** The Stationery Office, 2007.

**Health Technical Memorandum 06-01: Electrical services: supply and distribution.** The Stationery Office, 2007.

**Health Technical Memorandum 08-02: Lifts.** Department of Health, 2010.

## British and European Standards

The latest version of any standard should be used, provided that it continues to address the

relevant requirements of these recommendations.

**BS 476-4:1970.** Fire tests on building materials and structures. Non-combustibility test for materials. British Standards Institution, 1970.

**BS 476-6:1989+a1:2009.** Fire tests on building materials and structures. Method of test for fire propagation for products. British Standards Institution, 2009.

**BS 476-7:1997.** Fire tests on building materials and structures. Method of test to determine the classification of the surface spread of flame of products. British Standards Institution, 1997.

**BS 476-11:1982.** Fire tests on building materials and structures. Method for assessing the heat emission from building materials. British Standards Institution, 1982.

**BS 476-20:1987.** Fire tests on building materials and structures. Method for determination of the fire resistance of elements of construction (general principles). British Standards Institution, 1987.

**BS 476-21:1987.** Fire tests on building materials and structures. Methods for determination of the fire resistance of loadbearing elements of construction. British Standards Institution, 1987.

**BS 476-22:1987.** Fire tests on building materials and structures. Methods for determination of the fire resistance of non-loadbearing elements of construction. British Standards Institution, 1987.

**BS 476-23:1987.** Fire tests on building materials and structures. Methods for determination of the contribution of components to the fire resistance of a structure. British Standards Institution, 1987.

**BS 476-24:1987, ISO 6944:1985.** Fire tests on building materials and structures. Method for determination of the fire resistance of ventilation ducts. British Standards Institution, 1987.

- BS 476-31.1:1983.** Fire tests on building materials and structures. Methods for measuring smoke penetration through doorsets and shutter assemblies. Method of measurement under ambient temperature conditions. British Standards Institution, 1983.
- BS 1635:1990.** Recommendations for graphic symbols and abbreviations for fire protection drawings. British Standards Institution, 1990.
- BS 3251:1976.** Specification. Indicator plates for fire hydrants and emergency water supplies. British Standards Institution, 1976.
- BS 5266-1:2011.** Emergency lighting. Code of practice for the emergency lighting of premises. British Standards Institution, 2011.
- BS 5306-1:2006.** Code of practice for fire extinguishing installations and equipment on premises. Hose reels and foam inlets. British Standards Institution, 2006.
- BS EN 12845:2004+A2:2009.** Fixed firefighting systems. Automatic sprinkler systems. Design, installation and maintenance. British Standards Institution, 2009.
- BS 5306-3:2009.** Fire extinguishing installations and equipment on premises. Commissioning and maintenance of portable fire extinguishers. Code of practice. British Standards Institution, 2009.
- BS 5306-8:2012.** Fire extinguishing installations and equipment on premises. Selection and positioning of portable fire extinguishers. Code of practice. British Standards Institution, 2012.
- BS 5588-5:2004.** Fire precautions in the design, construction and use of buildings. Access and facilities for fire-fighting. British Standards Institution, 2004.
- BS 5588-7:1997.** Fire precautions in the design, construction and use of buildings. Code of practice for the incorporation of atria in buildings. British Standards Institution, 1997.
- BS 5588-8:1999.** Fire precautions in the design, construction and use of buildings. Code of practice for means of escape for disabled people. British Standards Institution, 1999.
- BS 5588-9:1999.** Fire precautions in the design, construction and use of buildings. Code of practice for ventilation and air conditioning ductwork. British Standards Institution, 1999.
- BS 5588-12:2004.** Fire precautions in the design, construction and use of buildings. Managing fire safety. British Standards Institution, 2004.
- BS 5839-1:2002+A2:2008.** Fire detection and fire alarm systems for buildings. Code of practice for system design, installation, commissioning and maintenance. British Standards Institution, 2008.
- BS 5839-3:1988.** Fire detection and alarm systems for buildings. Specification for automatic release mechanisms for certain fire protection equipment. British Standards Institution, 1988.
- BS 5867-2:2008.** Fabrics for curtains, drapes and window blinds. Flammability requirements. Specification. British Standards Institution, 2008.
- BS EN 12600:2002.** Glass in building. Pendulum test. Impact test method and classification for flat glass. British Standards Institution, 2002.
- BS 7863:2009.** Recommendations for colour coding to indicate the extinguishing media contained in portable fire extinguishers. British Standards Institution, 2009.
- BS 9990:2006.** Code of practice for non-automatic fire-fighting systems in buildings. British Standards Institution, 2006.
- BS EN 3-8:2006.** Portable fire extinguishers. Additional requirements to EN 3-7 for the construction, resistance to pressure and mechanical tests for extinguishers with a

maximum allowable pressure equal to or lower than 30 bar. British Standards Institution, 2006.

**BS EN 3-9:2006.** Portable fire extinguishers. Additional requirements to EN 3-7 for pressure resistance of CO<sub>2</sub> extinguishers. British Standards Institution, 2006.

**BS EN 3-10:2009.** Portable fire extinguishers. Provisions for evaluating the conformity of a portable fire extinguisher to EN 3-7. British Standards Institution, 2009.

**BS EN 3-7:2004+A1:2007.** Portable fire extinguishers. Characteristics, performance requirements and test methods. British Standards Institution, 2007.

**BS EN 54.** Fire detection and fire alarm systems. (12 parts). British Standards Institution.

**BS EN 81-1:1998+A3:2009.** Safety rules for the construction and installation of lifts. Electric lifts. British Standards Institution, 2009.

**BS EN 81-2:1998+A3:2009.** Safety rules for the construction and installation of lifts. Hydraulic lifts. British Standards Institution, 2009.

**BS EN 81-58:2003.** Safety rules for the construction and installation of lifts. Examination and tests. Landing doors fire resistance test. British Standards Institution, 2003.

**BS EN 81-72:2003.** Safety rules for the construction and installation of lifts. Particular applications for passenger and goods passenger lifts. Firefighters' lifts. British Standards Institution, 2003.

**BS EN 1154:1997.** Building hardware. Controlled door closing devices. Requirements and test methods. British Standards Institution, 1997.

**BS EN 1155:1997.** Building hardware. Electrically powered hold-open devices for swing doors. Requirements and test methods. British Standards Institution, 1997.

**BS EN 1366-2:1999.** Fire resistance tests for service installations. Fire dampers. British Standards Institution, 1999.

**BS EN 1634-1:2014.** Fire resistance and smoke control tests for door and shutter assemblies, openable windows and elements of building hardware. Fire resistance test for door and shutter assemblies and openable windows. British Standards Institution, 2014.

**BS EN 1634-3:2004.** Fire resistance tests for door and shutter assemblies. Smoke control doors and shutters. British Standards Institution, 2004.

**BS EN 12101-3:2002.** Smoke and heat control systems. Specification for powered smoke and heat exhaust ventilators. British Standards Institution, 2002.

**BS EN 12101-6:2005.** Smoke and heat control systems. Specification for pressure differential systems. Kits. British Standards Institution, 2005.

**BS EN 12600:2002.** Glass in building. Pendulum test. Impact test method and classification for flat glass. British Standards Institution, 2002.

**BS EN 12845:2004+A2:2009.** Fixed firefighting systems. Automatic sprinkler systems. Design, installation and maintenance. British Standards Institution, 2009.

**BS EN 13501-3:2005+A1:2009.** Fire classification of construction products and building elements. Classification using data from fire resistance tests on products and elements used in building service installations: fire resisting ducts and fire dampers. British Standards Institution, 2009.

**BS 2782-0:2011.** Methods of testing plastic. Part 0: Introduction. British Standards Institution, 2011.

**BS ISO 10294-5:2005.** Fire-resistance tests. Fire dampers for air distribution systems.

Intumescent fire dampers. British Standards Institution, 2005.

## Other publications

Building Research Establishment. **BRE Report 187: External fire spread: building separation and boundary distances.** BREPress, 1991.

Building Research Establishment. **BRE Digest 208: Increasing the fire resistance of existing timber floors.** BREPress, 1988.

Building Research Establishment. **BD 2466: Guidance on emergency use of lifts or escalators and fire and rescue service operation.** Department for Communities and Local Government, 2009.

Building Research Establishment. **BRE Report 368: Design methodologies for smoke and heat exhaust ventilation.** BREPress, 1999.

Chartered Institution of Building Services Engineers (CIBSE). **Lighting Guide 02: Hospitals and Health Care Buildings** (Society of Light and Lighting SLL LG2). CIBSE, 2008.

Fire Protection Association. **LPC rules for automatic sprinkler installations.** Fire Protection Association, 2009 (includes technical bulletins).

<http://www.thefpa.co.uk>

Health & Safety Executive. **Fire safety in construction. HSG168.** HSE Books, 2010.  
<http://www.hse.gov.uk/pubns/books/hsg168.htm>

International Association for Cold Storage Construction (IACSC) (European Division). **Design, construction, specification and fire management of insulated envelopes for temperature controlled environments.** IACSC, 1999).

## Appendix L: Summary of changes to the April 2014 edition

**Page 10** – paragraph 2.36, last line: “HTM 05-03 series” replaced with “HTM 05-03: Part B”.

**Page 12** – first line: “Acute mental patients” replaced with “Patients with an acute mental illness or learning disabilities”.

**Page 27** – paragraph 3.43 final sentence amended to read: “Therefore all stairways, other than those contained within and only serving an atrium, should be designed as escape stairways to permit vertical evacuation by the most appropriate method, see paragraphs 3.53 to 3.55.”

**Page 28** – paragraph 3.55: “dependent” replaced with “independent”.

**Page 31** – paragraph 3.64, fourth line: “a intensive” replaced with “an intensive”.

**Page 32** – paragraph 3.69: add after last sentence, “See paragraphs 3.70 to 3.73”.

**Page 36** – paragraph 4.6, first line; paragraph 4.8, third line; and paragraph 4.9, third line: “(see Appendix C)” replaced with “(see Appendix D)”

**Page 41** – paragraph 5.19: “Appendix B” replaced with “Appendix A”.

**Page 44** – Table 6 deleted and replaced with the following Table:

Chemical stores	Store rooms
Cleaners’ room	Relatives’ overnight stay room
Clothes storage	Ward kitchens
Disposal rooms	Communal bathrooms in mental health premises (see <a href="#">paragraph 2.52</a> )
Hub rooms	Linen stores
Lift motor rooms	Staff on-call rooms
Main staff changing and locker rooms	Patient bedrooms provided specifically for: <ul style="list-style-type: none"> <li>• people with mental health needs</li> <li>• people with learning disabilities</li> </ul>

Key

	Doors to these rooms to be kept locked shut
--	---

	Door to be fitted with appropriately designed free-swing self-closing devices
	Doors to be fitted with self-closing devices
	Self-closing devices not required.

Table 6 Examples of fire hazard rooms

Table 6 Example of fire hazard rooms

**Page 48** – paragraph 5.62, third line: “6.48” replaced with “5.66”.

**Page 50** – paragraph 5.65(d): after “smoke damper”, “ – see Table 7” has been inserted.

**Page 51** – paragraph 5.78: sub-paragraph (c) has been deleted.

**Page 60** – paragraph 7.4, line 2: “Table 7” replaced with “Table 10”.

**Page 73** – Table C1 deleted and replaced with the following table:

Table C1 Location of fire doors

Location of door	Minimum period of fire resistance in terms of integrity (minutes) when tested to BS 476-22 <sup>1</sup>	Minimum period of fire resistance in terms of integrity (minutes) when tested to European standards <sup>2</sup>
Sub-compartment wall	FD30S	E30 S <sub>a</sub>
Fire hazard rooms	FD30S	E30 S <sub>a</sub>
In a compartment wall	FD30S – Single-storey healthcare buildings	E30 S <sub>a</sub>
	FD30S – Storeys above ground in healthcare buildings fitted with sprinklers	E30 S <sub>a</sub>
	FD60S – elsewhere	E60 S <sub>a</sub>
<b>To a protected shaft containing a stairway or escalator:</b>		
a. accessed from a hospital street	FD30S	E30 S <sub>a</sub>
b. elsewhere	FD30S to each of the two sets of doors to the lobby	E30 S <sub>a</sub>
<b>To a protected shaft containing a lift<sup>3</sup>:</b>		
a. accessed from a hospital street	FD30	E30
b. elsewhere	FD30S to the doors from the circulation space to the lobby	E30 S <sub>a</sub>
	FD30 from the lift car to the lobby	E30
To a protected shaft containing chutes, ducts and pipes	FD60S	E60 S <sub>a</sub>
Within a cavity barrier	FD30*	E30

*Continued over page*

**Notes:**

1. To BS 476-22 (or BS 476-8 subject to paragraph 5 in Appendix A of Approved Document B).
2. The national classifications do not automatically equate with the equivalent classifications in the European column; therefore, products cannot typically assume a European class unless they have been tested accordingly.  
Unless pressurisation techniques complying with BS EN 12101-6:2005 are used, all these doors (except those marked \*) should also either:
  - (a) have a leakage rate not exceeding 3 m<sup>3</sup>/m/hour (head and jambs only) when tested at 25 Pa under BS 476-31.1; or
  - (b) meet the additional classification requirement of S<sub>a</sub> when tested to BS EN 1634-3.
3. Lift doors to be tested to BS EN 81-58.

**Page 74** – First paragraph up to third bullet has been omitted and replaced with:

“Generally all fire doors should be fitted with an automatic self-closing device complying with BS EN 1154 or BS EN 1634-1, with the following exceptions:

- fire doors to patients’ bedrooms in facilities providing in-patient mental health services;
- fire doors to bedrooms in facilities for people with learning disabilities; and
- fire doors which are kept locked shut.

With the exception of doors to stairways, it may be acceptable for fire doors to be held open on electrically operated door-release mechanisms provided that all of the following criteria can be satisfied:”

List of criteria to remain unaltered.

Final sentence has been added: “Please note: The installation of operation of electro-magnetic hold open/swing free door closers should also satisfy similar criteria.”

**Page 92** After the “BS EN 81-2: 1998+A3 2009” reference, the following new reference has been inserted:

“BS EN 81-58 Safety rules for the construction and installation of lifts. Examination and tests. Landing doors fire resistance test. British Standards Institute, 2003”

After the “BS EN 1154: 1997” reference, the following new reference has been inserted:

“BS EN 1155: 1997. Building hardware. Electrically powered hold-open devices for swing doors. Requirements and test methods. British Standards Institute, 1997”.